

# 超硬製品

Tungsten Carbide

# KDS-2

超硬ストレートドリル  
Tungsten Carbide straight Drill

- 一般鋼～アルミまで幅広い被削材が加工可能です。  
A wide range of work materials can be processed, from general steel to aluminum.
- 様々な用途での使用が可能な汎用ドリルです。  
General-purpose drill that can be used for various purposes.
- φ0.3～φ3.0まで0.01とびにラインナップ  
Line-upped φ0.1～φ3atpitch0.01

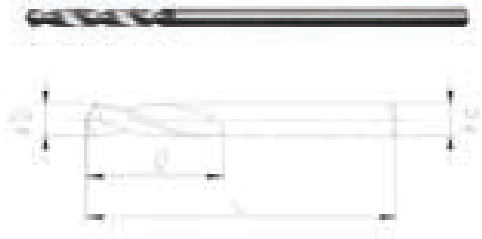

超微粒子合金 Micro Grain Tungsten Carbide



刃径の許容差 Flute Diameter Tolerance  
D1 0～-0.005



柄径の許容差 Shank Diameter Tolerance  
d 0～-0.005



ネジレ角30° Twist Angle 30°



先端角度 Chamfer Angle Single 118°  
0.3 ≤ D < 2.1 118°  
2.1 ≤ D ≤ 3.0 135°

●切削条件表はP195に記載

単位[寸法: mm/価格: 円]

●Cutting conditions are recommended on page 195.

Unit [size: mm/Retail Price: JPY]

品番 Code No.	刃径 D1 Flute Diameter	刃長 ℓ Flute Length	全長 L Total Length	標準価格 Retail Price
KDS-2030	0.3	4	30	2,400
KDS-2031	0.31	4	30	2,860
KDS-2032	0.32	4	30	2,860
KDS-2033	0.33	4	30	2,860
KDS-2034	0.34	4	30	2,860
KDS-2035	0.35	4	30	2,860
KDS-2036	0.36	4	30	2,860
KDS-2037	0.37	4	30	2,860
KDS-2038	0.38	4	30	2,860
KDS-2039	0.39	4	30	2,860
KDS-2040	0.4	5	30	2,150
KDS-2041	0.41	5	30	2,590
KDS-2042	0.42	5	30	2,590
KDS-2043	0.43	5	30	2,590
KDS-2044	0.44	5	30	2,590
KDS-2045	0.45	5	30	2,590
KDS-2046	0.46	5	30	2,590
KDS-2047	0.47	5	30	2,590
KDS-2048	0.48	5	30	2,590
KDS-2049	0.49	5	30	2,590
KDS-2050	0.5	6	30	1,790
KDS-2051	0.51	6	30	2,120
KDS-2052	0.52	6	30	2,120
KDS-2053	0.53	6	30	2,120
KDS-2054	0.54	6	30	2,120
KDS-2055	0.55	6	30	2,120
KDS-2056	0.56	6	30	2,120
KDS-2057	0.57	6	30	2,120
KDS-2058	0.58	6	30	2,120
KDS-2059	0.59	6	30	2,120

品番 Code No.	刃径 D1 Flute Diameter	刃長 ℓ Flute Length	全長 L Total Length	標準価格 Retail Price
KDS-2060	0.6	6	30	1,790
KDS-2061	0.61	6	30	2,120
KDS-2062	0.62	6	30	2,120
KDS-2063	0.63	6	30	2,120
KDS-2064	0.64	6	30	2,120
KDS-2065	0.65	6	30	2,120
KDS-2066	0.66	6	30	2,120
KDS-2067	0.67	6	30	2,120
KDS-2068	0.68	6	30	2,120
KDS-2069	0.69	6	30	2,120
KDS-2070	0.7	12	40	1,790
KDS-2071	0.71	12	40	2,120
KDS-2072	0.72	12	40	2,120
KDS-2073	0.73	12	40	2,120
KDS-2074	0.74	12	40	2,120
KDS-2075	0.75	12	40	2,120
KDS-2076	0.76	12	40	2,120
KDS-2077	0.77	12	40	2,120
KDS-2078	0.78	12	40	2,120
KDS-2079	0.79	12	40	2,120
KDS-2080	0.8	12	40	1,790
KDS-2081	0.81	12	40	2,120
KDS-2082	0.82	12	40	2,120
KDS-2083	0.83	12	40	2,120
KDS-2084	0.84	12	40	2,120
KDS-2085	0.85	12	40	2,120
KDS-2086	0.86	12	40	2,120
KDS-2087	0.87	12	40	2,120
KDS-2088	0.88	12	40	2,120
KDS-2089	0.89	12	40	2,120

超硬製品

Tungsten Carbide

# KDS-2

品番 Code No.	刃径 D1 Flute Diameter	刃長 ℓ Flute Length	全長 L Total Length	標準価格 Retail Price
KDS-2090	0.9	12	40	1,790
KDS-2091	0.91	12	40	2,120
KDS-2092	0.92	12	40	2,120
KDS-2093	0.93	12	40	2,120
KDS-2094	0.94	12	40	2,120
KDS-2095	0.95	12	40	2,120
KDS-2096	0.96	12	40	2,120
KDS-2097	0.97	12	40	2,120
KDS-2098	0.98	12	40	2,120
KDS-2099	0.99	12	40	2,120
KDS-2100	1	15	40	1,790
KDS-2101	1.01	15	40	2,120
KDS-2102	1.02	15	40	2,120
KDS-2103	1.03	15	40	2,120
KDS-2104	1.04	15	40	2,120
KDS-2105	1.05	15	40	2,120
KDS-2106	1.06	15	40	2,120
KDS-2107	1.07	15	40	2,120
KDS-2108	1.08	15	40	2,120
KDS-2109	1.09	15	40	2,120
KDS-2110	1.1	15	40	1,790
KDS-2111	1.11	15	40	2,120
KDS-2112	1.12	15	40	2,120
KDS-2113	1.13	15	40	2,120
KDS-2114	1.14	15	40	2,120
KDS-2115	1.15	15	40	2,120
KDS-2116	1.16	15	40	2,120
KDS-2117	1.17	15	40	2,120
KDS-2118	1.18	15	40	2,120
KDS-2119	1.19	15	40	2,120
KDS-2120	1.2	15	40	1,790
KDS-2121	1.21	15	40	2,120
KDS-2122	1.22	15	40	2,120
KDS-2123	1.23	15	40	2,120
KDS-2124	1.24	15	40	2,120
KDS-2125	1.25	15	40	2,120
KDS-2126	1.26	15	40	2,120
KDS-2127	1.27	15	40	2,120
KDS-2128	1.28	15	40	2,120
KDS-2129	1.29	15	40	2,120
KDS-2130	1.3	16	40	1,790
KDS-2131	1.31	16	40	2,120
KDS-2132	1.32	16	40	2,120
KDS-2133	1.33	16	40	2,120
KDS-2134	1.34	16	40	2,120
KDS-2135	1.35	16	40	2,120
KDS-2136	1.36	16	40	2,120
KDS-2137	1.37	16	40	2,120

品番 Code No.	刃径 D1 Flute Diameter	刃長 ℓ Flute Length	全長 L Total Length	標準価格 Retail Price
KDS-2138	1.38	16	40	2,120
KDS-2139	1.39	16	40	2,120
KDS-2140	1.4	16	40	1,790
KDS-2141	1.41	16	40	2,120
KDS-2142	1.42	16	40	2,120
KDS-2143	1.43	16	40	2,120
KDS-2144	1.44	16	40	2,120
KDS-2145	1.45	16	40	2,120
KDS-2146	1.46	16	40	2,120
KDS-2147	1.47	16	40	2,120
KDS-2148	1.48	16	40	2,120
KDS-2149	1.49	16	40	2,120
KDS-2150	1.5	16	40	1,790
KDS-2151	1.51	16	40	2,490
KDS-2152	1.52	16	40	2,490
KDS-2153	1.53	16	40	2,490
KDS-2154	1.54	16	40	2,490
KDS-2155	1.55	16	40	2,490
KDS-2156	1.56	16	40	2,490
KDS-2157	1.57	16	40	2,490
KDS-2158	1.58	16	40	2,490
KDS-2159	1.59	16	40	2,490
KDS-2160	1.6	18	40	2,090
KDS-2161	1.61	18	40	2,490
KDS-2162	1.62	18	40	2,490
KDS-2163	1.63	18	40	2,490
KDS-2164	1.64	18	40	2,490
KDS-2165	1.65	18	40	2,490
KDS-2166	1.66	18	40	2,490
KDS-2167	1.67	18	40	2,490
KDS-2168	1.68	18	40	2,490
KDS-2169	1.69	18	40	2,490
KDS-2170	1.7	18	40	2,090
KDS-2171	1.71	18	40	2,490
KDS-2172	1.72	18	40	2,490
KDS-2173	1.73	18	40	2,490
KDS-2174	1.74	18	40	2,490
KDS-2175	1.75	18	40	2,490
KDS-2176	1.76	18	40	2,490
KDS-2177	1.77	18	40	2,490
KDS-2178	1.78	18	40	2,490
KDS-2179	1.79	18	40	2,490
KDS-2180	1.8	18	40	2,090
KDS-2181	1.81	18	40	2,490
KDS-2182	1.82	18	40	2,490
KDS-2183	1.83	18	40	2,490
KDS-2184	1.84	18	40	2,490
KDS-2185	1.85	18	40	2,490

# KDS-2

品番 Code No.	刃径 D1 Flute Diameter	刃長 ℓ Flute Length	全長 L Total Length	標準価格 Retail Price
KDS-2186	1.86	18	40	2,490
KDS-2187	1.87	18	40	2,490
KDS-2188	1.88	18	40	2,490
KDS-2189	1.89	18	40	2,490
KDS-2190	1.9	18	40	2,090
KDS-2191	1.91	18	40	2,490
KDS-2192	1.92	18	40	2,490
KDS-2193	1.93	18	40	2,490
KDS-2194	1.94	18	40	2,490
KDS-2195	1.95	18	40	2,490
KDS-2196	1.96	18	40	2,490
KDS-2197	1.97	18	40	2,490
KDS-2198	1.98	18	40	2,490
KDS-2199	1.99	18	40	2,490
KDS-2200	2	18	40	2,090
KDS-2201	2.01	18	40	2,680
KDS-2202	2.02	18	40	2,680
KDS-2203	2.03	18	40	2,680
KDS-2204	2.04	18	40	2,680
KDS-2205	2.05	18	40	2,680
KDS-2206	2.06	18	40	2,680
KDS-2207	2.07	18	40	2,680
KDS-2208	2.08	18	40	2,680
KDS-2209	2.09	18	40	2,680
KDS-2210	2.1	20	45	2,250
KDS-2211	2.11	20	45	2,680
KDS-2212	2.12	20	45	2,680
KDS-2213	2.13	20	45	2,680
KDS-2214	2.14	20	45	2,680
KDS-2215	2.15	20	45	2,680
KDS-2216	2.16	20	45	2,680
KDS-2217	2.17	20	45	2,680
KDS-2218	2.18	20	45	2,680
KDS-2219	2.19	20	45	2,680
KDS-2220	2.2	20	45	2,250
KDS-2221	2.21	20	45	2,680
KDS-2222	2.22	20	45	2,680
KDS-2223	2.23	20	45	2,680
KDS-2224	2.24	20	45	2,680
KDS-2225	2.25	20	45	2,680
KDS-2226	2.26	20	45	2,680
KDS-2227	2.27	20	45	2,680
KDS-2228	2.28	20	45	2,680
KDS-2229	2.29	20	45	2,680
KDS-2230	2.3	20	45	2,250
KDS-2231	2.31	20	45	2,680
KDS-2232	2.32	20	45	2,680
KDS-2233	2.33	20	45	2,680

品番 Code No.	刃径 D1 Flute Diameter	刃長 ℓ Flute Length	全長 L Total Length	標準価格 Retail Price
KDS-2234	2.34	20	45	2,680
KDS-2235	2.35	20	45	2,680
KDS-2236	2.36	20	45	2,680
KDS-2237	2.37	20	45	2,680
KDS-2238	2.38	20	45	2,680
KDS-2239	2.39	20	45	2,680
KDS-2240	2.4	20	45	2,250
KDS-2241	2.41	20	45	2,680
KDS-2242	2.42	20	45	2,680
KDS-2243	2.43	20	45	2,680
KDS-2244	2.44	20	45	2,680
KDS-2245	2.45	20	45	2,680
KDS-2246	2.46	20	45	2,680
KDS-2247	2.47	20	45	2,680
KDS-2248	2.48	20	45	2,680
KDS-2249	2.49	20	45	2,680
KDS-2250	2.5	20	45	2,250
KDS-2251	2.51	20	45	3,230
KDS-2252	2.52	20	45	3,230
KDS-2253	2.53	20	45	3,230
KDS-2254	2.54	20	45	3,230
KDS-2255	2.55	20	45	3,230
KDS-2256	2.56	20	45	3,230
KDS-2257	2.57	20	45	3,230
KDS-2258	2.58	20	45	3,230
KDS-2259	2.59	20	45	3,230
KDS-2260	2.6	20	45	2,710
KDS-2261	2.61	20	45	3,230
KDS-2262	2.62	20	45	3,230
KDS-2263	2.63	20	45	3,230
KDS-2264	2.64	20	45	3,230
KDS-2265	2.65	20	45	3,230
KDS-2266	2.66	20	45	3,230
KDS-2267	2.67	20	45	3,230
KDS-2268	2.68	20	45	3,230
KDS-2269	2.69	20	45	3,230
KDS-2270	2.7	20	45	2,710
KDS-2271	2.71	20	45	3,230
KDS-2272	2.72	20	45	3,230
KDS-2273	2.73	20	45	3,230
KDS-2274	2.74	20	45	3,230
KDS-2275	2.75	20	45	3,230
KDS-2276	2.76	20	45	3,230
KDS-2277	2.77	20	45	3,230
KDS-2278	2.78	20	45	3,230
KDS-2279	2.79	20	45	3,230
KDS-2280	2.8	20	45	2,710
KDS-2281	2.81	20	45	3,230

超硬製品

Tungsten Carbide



# KDSL-2

超硬ストレートセミロングドリル  
Tungsten Carbide straight semi-long Drill

- 一般鋼～アルミまで幅広い被削材が加工可能です。  
A wide range of work materials can be processed, from general steel to aluminum.
- 様々な用途での使用が可能な汎用ドリルです。  
General-purpose drill that can be used for various purposes.



超微粒子合金 Micro Grain Tungsten Carbide



刃径の許容差 Flute Diameter Tolerance  
D1 0～-0.01



柄径の許容差 Shank Diameter Tolerance  
d 0～-0.01



ネジレ角30° Twist Angle 30°



先端角度 Chamfer Angle Single 118°  
0.3 ≤ D < 2.1 118°  
2.1 ≤ D ≤ 3.0 135°

●切削条件表はP195に記載  
●Cutting conditions are recommended on page 195.

単位[寸法:mm/価格:円]  
Unit [size:mm/Retail Price:JPY]

品番 Code No.	刃径 D1 Flute Diameter	刃長 l Flute Length	全長 L Total Length	標準価格 Retail Price
KDSL-2030	0.3	8	40	2,430
KDSL-2035	0.35	8	40	2,920
KDSL-2040	0.4	8	40	2,430
KDSL-2045	0.45	8	40	2,920
KDSL-2050	0.5	8	40	2,060
KDSL-2055	0.55	8	40	2,460
KDSL-2060	0.6	8	40	2,000
KDSL-2065	0.65	8	40	2,400
KDSL-2070	0.7	15	50	2,000
KDSL-2075	0.75	15	50	2,400
KDSL-2080	0.8	15	50	2,000
KDSL-2085	0.85	15	50	2,400
KDSL-2090	0.9	15	50	2,000
KDSL-2095	0.95	15	50	2,520
KDSL-2100	1	16	50	2,090
KDSL-2105	1.05	16	50	2,520
KDSL-2110	1.1	16	50	2,090
KDSL-2115	1.15	16	50	2,520
KDSL-2120	1.2	18	50	2,090
KDSL-2125	1.25	18	50	2,520
KDSL-2130	1.3	18	50	2,090
KDSL-2135	1.35	18	50	2,520
KDSL-2140	1.4	18	50	2,090
KDSL-2145	1.45	18	50	2,520
KDSL-2150	1.5	24	55	2,090
KDSL-2155	1.55	24	55	2,830
KDSL-2160	1.6	24	55	2,370
KDSL-2165	1.65	24	55	2,830
KDSL-2170	1.7	24	55	2,370
KDSL-2175	1.75	24	55	2,830

品番 Code No.	刃径 D1 Flute Diameter	刃長 l Flute Length	全長 L Total Length	標準価格 Retail Price
KDSL-2180	1.8	24	55	2,370
KDSL-2185	1.85	24	55	2,830
KDSL-2190	1.9	24	55	2,370
KDSL-2195	1.95	24	55	3,020
KDSL-2200	2	24	55	2,520
KDSL-2205	2.05	24	55	3,020
KDSL-2210	2.1	24	55	2,520
KDSL-2215	2.15	24	55	3,020
KDSL-2220	2.2	26	65	2,520
KDSL-2225	2.25	26	65	3,020
KDSL-2230	2.3	26	65	2,520
KDSL-2235	2.35	26	65	3,200
KDSL-2240	2.4	26	65	2,650
KDSL-2245	2.45	26	65	3,200
KDSL-2250	2.5	26	65	2,650
KDSL-2255	2.55	26	65	3,690
KDSL-2260	2.6	28	65	3,080
KDSL-2265	2.65	28	65	3,690
KDSL-2270	2.7	28	65	3,080
KDSL-2275	2.75	28	65	3,690
KDSL-2280	2.8	30	75	3,080
KDSL-2285	2.85	30	75	3,690
KDSL-2290	2.9	30	75	3,080
KDSL-2295	2.95	30	75	3,690
KDSL-2300	3	30	75	3,080

超硬製品

Tungsten Carbide







# KDR-2

超硬ルーマ型ドリル  
Tungsten Carbide 2 Flutes Micro Drill



- 刃径0.03及び0.04の形状
- Shape of Flute Diameter 0.03 and 0.04

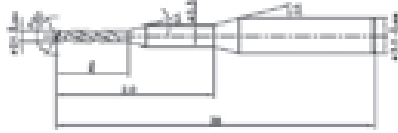

- 刃径0.05以上の形状
- Shape of Flute Diameter more than 0.05



超微粒子合金 Micro Grain Tungsten Carbide



刃径の許容差 Flute Diameter Tolerance  
D1 0~-0.004



柄径の許容差 Shank Diameter Tolerance  
d 0~-0.006



ネジレ角30° Twist Angle 30°



先端角度120° Point Angle 120°

- 切削条件表はP196に記載
- Cutting conditions are recommended on page 196.

単位[寸法:mm/価格:円]  
Unit [size:mm/Retail Price:JPY]

品番 Code No.	刃径 D1 Flute Diameter	刃長 ℓ Flute Length	全長 L Total Length	柄径 d Shank Diameter	標準価格 Retail Price
KDR-2003	0.03	0.3	38	3	18,000
KDR-2004	0.04	0.4	38	3	12,000
KDR-2005	0.05	0.5	38	3	10,200
KDR-2006	0.06	0.6	38	3	9,340
KDR-2007	0.07	0.7	38	3	8,400
KDR-2008	0.08	0.8	38	3	7,200
KDR-2009	0.09	0.9	38	3	6,300
KDR-2010	0.1	1.2	38	3	4,870
KDR-2011	0.11	1.2	38	3	4,870
KDR-2012	0.12	1.4	38	3	4,870
KDR-2013	0.13	1.4	38	3	4,870
KDR-2014	0.14	1.4	38	3	4,870
KDR-2015	0.15	1.8	38	3	4,870
KDR-2016	0.16	1.8	38	3	4,870
KDR-2017	0.17	1.8	38	3	4,870
KDR-2018	0.18	2.1	38	3	4,440
KDR-2019	0.19	2.1	38	3	4,440
KDR-2020	0.2	2.4	38	3	4,440
KDR-2021	0.21	2.4	38	3	4,000
KDR-2022	0.22	2.6	38	3	4,000

品番 Code No.	刃径 D1 Flute Diameter	刃長 ℓ Flute Length	全長 L Total Length	柄径 d Shank Diameter	標準価格 Retail Price
KDR-2023	0.23	2.6	38	3	4,000
KDR-2024	0.24	2.6	38	3	4,000
KDR-2025	0.25	3	38	3	4,000
KDR-2026	0.26	3	38	3	4,000
KDR-2027	0.27	3	38	3	4,000
KDR-2028	0.28	3.3	38	3	4,000
KDR-2029	0.29	3.3	38	3	4,000
KDR-2030	0.3	5	38	3	4,000
KDR-2031	0.31	5	38	3	3,000
KDR-2032	0.32	5	38	3	3,000
KDR-2033	0.33	5	38	3	3,000
KDR-2034	0.34	5	38	3	3,000
KDR-2035	0.35	5	38	3	3,000
KDR-2036	0.36	5	38	3	3,000
KDR-2037	0.37	5	38	3	3,000
KDR-2038	0.38	5	38	3	3,000
KDR-2039	0.39	5	38	3	3,000
KDR-2040	0.4	6	38	3	3,000
KDR-2041	0.41	6	38	3	3,000
KDR-2042	0.42	6	38	3	3,000
KDR-2043	0.43	6	38	3	3,000
KDR-2044	0.44	6	38	3	3,000
KDR-2045	0.45	6	38	3	3,000
KDR-2046	0.46	6	38	3	3,000
KDR-2047	0.47	6	38	3	3,000
KDR-2048	0.48	6	38	3	3,000
KDR-2049	0.49	6	38	3	3,000
KDR-2050	0.5	6	38	3	3,000
KDR-2051	0.51	6	38	3	3,000
KDR-2052	0.52	6	38	3	3,000
KDR-2053	0.53	6	38	3	3,000
KDR-2054	0.54	6	38	3	3,000
KDR-2055	0.55	6	38	3	3,000
KDR-2056	0.56	6	38	3	3,000
KDR-2057	0.57	6	38	3	3,000
KDR-2058	0.58	6	38	3	3,000
KDR-2059	0.59	6	38	3	3,000
KDR-2060	0.6	7	38	3	3,000
KDR-2061	0.61	7	38	3	3,000
KDR-2062	0.62	7	38	3	3,000
KDR-2063	0.63	7	38	3	3,000
KDR-2064	0.64	7	38	3	3,000
KDR-2065	0.65	7	38	3	3,000
KDR-2066	0.66	7	38	3	3,000
KDR-2067	0.67	7	38	3	3,000
KDR-2068	0.68	7	38	3	3,000
KDR-2069	0.69	7	38	3	3,000
KDR-2070	0.7	8	38	3	3,000

# KDR-2

品番 Code No.	刃径 D1 Flute Diameter	刃長 ℓ Flute Length	全長 L Total Length	柄径 d Shank Diameter	標準価格 Retail Price
KDR-2071	0.71	8	38	3	3,000
KDR-2072	0.72	8	38	3	3,000
KDR-2073	0.73	8	38	3	3,000
KDR-2074	0.74	8	38	3	3,000
KDR-2075	0.75	8	38	3	3,000
KDR-2076	0.76	8	38	3	3,000
KDR-2077	0.77	8	38	3	3,000
KDR-2078	0.78	8	38	3	3,000
KDR-2079	0.79	8	38	3	3,000
KDR-2080	0.8	8	38	3	3,000
KDR-2081	0.81	8	38	3	3,000
KDR-2082	0.82	8	38	3	3,000
KDR-2083	0.83	8	38	3	3,000
KDR-2084	0.84	8	38	3	3,000
KDR-2085	0.85	8	38	3	3,000
KDR-2086	0.86	8	38	3	3,000
KDR-2087	0.87	8	38	3	3,000
KDR-2088	0.88	8	38	3	3,000
KDR-2089	0.89	8	38	3	3,000
KDR-2090	0.9	8	38	3	3,000
KDR-2091	0.91	8	38	3	3,000
KDR-2092	0.92	8	38	3	3,000
KDR-2093	0.93	8	38	3	3,000
KDR-2094	0.94	8	38	3	3,000
KDR-2095	0.95	8	38	3	3,000
KDR-2096	0.96	8	38	3	3,000
KDR-2097	0.97	8	38	3	3,000
KDR-2098	0.98	8	38	3	3,000
KDR-2099	0.99	8	38	3	3,000
KDR-2100	1	10	38	3	3,000
KDR-2101	1.01	10	38	3	3,000
KDR-2102	1.02	10	38	3	3,000
KDR-2103	1.03	10	38	3	3,000
KDR-2104	1.04	10	38	3	3,000
KDR-2105	1.05	10	38	3	3,000
KDR-2106	1.06	10	38	3	3,000
KDR-2107	1.07	10	38	3	3,000
KDR-2108	1.08	10	38	3	3,000
KDR-2109	1.09	10	38	3	3,000
KDR-2110	1.1	10	38	3	3,000
KDR-2111	1.11	10	38	3	3,000
KDR-2112	1.12	10	38	3	3,000
KDR-2113	1.13	10	38	3	3,000
KDR-2114	1.14	10	38	3	3,000
KDR-2115	1.15	10	38	3	3,000
KDR-2116	1.16	10	38	3	3,000
KDR-2117	1.17	10	38	3	3,000
KDR-2118	1.18	10	38	3	3,000

品番 Code No.	刃径 D1 Flute Diameter	刃長 ℓ Flute Length	全長 L Total Length	柄径 d Shank Diameter	標準価格 Retail Price
KDR-2119	1.19	10	38	3	3,000
KDR-2120	1.2	10	38	3	3,000
KDR-2121	1.21	10	38	3	3,000
KDR-2122	1.22	10	38	3	3,000
KDR-2123	1.23	10	38	3	3,000
KDR-2124	1.24	10	38	3	3,000
KDR-2125	1.25	10	38	3	3,000
KDR-2126	1.26	10	38	3	3,000
KDR-2127	1.27	10	38	3	3,000
KDR-2128	1.28	10	38	3	3,000
KDR-2129	1.29	10	38	3	3,000
KDR-2130	1.3	10	38	3	3,000
KDR-2131	1.31	10	38	3	3,000
KDR-2132	1.32	10	38	3	3,000
KDR-2133	1.33	10	38	3	3,000
KDR-2134	1.34	10	38	3	3,000
KDR-2135	1.35	10	38	3	3,000
KDR-2136	1.36	10	38	3	3,000
KDR-2137	1.37	10	38	3	3,000
KDR-2138	1.38	10	38	3	3,000
KDR-2139	1.39	10	38	3	3,000
KDR-2140	1.4	10	38	3	3,000
KDR-2141	1.41	10	38	3	3,000
KDR-2142	1.42	10	38	3	3,000
KDR-2143	1.43	10	38	3	3,000
KDR-2144	1.44	10	38	3	3,000
KDR-2145	1.45	10	38	3	3,000
KDR-2146	1.46	10	38	3	3,000
KDR-2147	1.47	10	38	3	3,000
KDR-2148	1.48	10	38	3	3,000
KDR-2149	1.49	10	38	3	3,000
KDR-2150	1.5	10	38	3	3,000
KDR-2151	1.51	10	38	3	3,000
KDR-2152	1.52	10	38	3	3,000
KDR-2153	1.53	10	38	3	3,000
KDR-2154	1.54	10	38	3	3,000
KDR-2155	1.55	10	38	3	3,000
KDR-2156	1.56	10	38	3	3,000
KDR-2157	1.57	10	38	3	3,000
KDR-2158	1.58	10	38	3	3,000
KDR-2159	1.59	10	38	3	3,000
KDR-2160	1.6	22	50	3	3,470
KDR-2161	1.61	22	50	3	3,470
KDR-2162	1.62	22	50	3	3,470
KDR-2163	1.63	22	50	3	3,470
KDR-2164	1.64	22	50	3	3,470
KDR-2165	1.65	22	50	3	3,470
KDR-2166	1.66	22	50	3	3,470

超硬製品

Tungsten Carbide

# KDR-2

品番 Code No.	刃径 D1 Flute Diameter	刃長 ℓ Flute Length	全長 L Total Length	柄径 d Shank Diameter	標準価格 Retail Price
KDR-2167	1.67	22	50	3	3,470
KDR-2168	1.68	22	50	3	3,470
KDR-2169	1.69	22	50	3	3,470
KDR-2170	1.7	22	50	3	3,470
KDR-2171	1.71	22	50	3	3,470
KDR-2172	1.72	22	50	3	3,470
KDR-2173	1.73	22	50	3	3,470
KDR-2174	1.74	22	50	3	3,470
KDR-2175	1.75	22	50	3	3,470
KDR-2176	1.76	22	50	3	3,470
KDR-2177	1.77	22	50	3	3,470
KDR-2178	1.78	22	50	3	3,470
KDR-2179	1.79	22	50	3	3,470
KDR-2180	1.8	22	50	3	3,470
KDR-2181	1.81	22	50	3	3,470
KDR-2182	1.82	22	50	3	3,470
KDR-2183	1.83	22	50	3	3,470
KDR-2184	1.84	22	50	3	3,470
KDR-2185	1.85	22	50	3	3,470
KDR-2186	1.86	22	50	3	3,470
KDR-2187	1.87	22	50	3	3,470
KDR-2188	1.88	22	50	3	3,470
KDR-2189	1.89	22	50	3	3,470
KDR-2190	1.9	22	50	3	3,470
KDR-2191	1.91	22	50	3	3,470
KDR-2192	1.92	22	50	3	3,470
KDR-2193	1.93	22	50	3	3,470
KDR-2194	1.94	22	50	3	3,470
KDR-2195	1.95	22	50	3	3,470
KDR-2196	1.96	22	50	3	3,470
KDR-2197	1.97	22	50	3	3,470
KDR-2198	1.98	22	50	3	3,470
KDR-2199	1.99	22	50	3	3,470
KDR-2200	2	22	50	3	3,470
KDR-2201	2.01	22	50	3	3,470
KDR-2202	2.02	22	50	3	3,470
KDR-2203	2.03	22	50	3	3,470
KDR-2204	2.04	22	50	3	3,470
KDR-2205	2.05	22	50	3	3,470
KDR-2206	2.06	22	50	3	3,470
KDR-2207	2.07	22	50	3	3,470
KDR-2208	2.08	22	50	3	3,470
KDR-2209	2.09	22	50	3	3,470
KDR-2210	2.1	22	50	3	3,470
KDR-2211	2.11	22	50	3	3,470
KDR-2212	2.12	22	50	3	3,470
KDR-2213	2.13	22	50	3	3,470
KDR-2214	2.14	22	50	3	3,470

品番 Code No.	刃径 D1 Flute Diameter	刃長 ℓ Flute Length	全長 L Total Length	柄径 d Shank Diameter	標準価格 Retail Price
KDR-2215	2.15	22	50	3	3,470
KDR-2216	2.16	22	50	3	3,470
KDR-2217	2.17	22	50	3	3,470
KDR-2218	2.18	22	50	3	3,470
KDR-2219	2.19	22	50	3	3,470
KDR-2220	2.2	22	50	3	3,600
KDR-2221	2.21	22	50	3	3,600
KDR-2222	2.22	22	50	3	3,600
KDR-2223	2.23	22	50	3	3,600
KDR-2224	2.24	22	50	3	3,600
KDR-2225	2.25	22	50	3	3,600
KDR-2226	2.26	22	50	3	3,600
KDR-2227	2.27	22	50	3	3,600
KDR-2228	2.28	22	50	3	3,600
KDR-2229	2.29	22	50	3	3,600
KDR-2230	2.3	22	50	3	3,600
KDR-2231	2.31	22	50	3	3,600
KDR-2232	2.32	22	50	3	3,600
KDR-2233	2.33	22	50	3	3,600
KDR-2234	2.34	22	50	3	3,600
KDR-2235	2.35	22	50	3	3,600
KDR-2236	2.36	22	50	3	3,600
KDR-2237	2.37	22	50	3	3,600
KDR-2238	2.38	22	50	3	3,600
KDR-2239	2.39	22	50	3	3,600
KDR-2240	2.4	22	50	3	3,600
KDR-2241	2.41	22	50	3	3,600
KDR-2242	2.42	22	50	3	3,600
KDR-2243	2.43	22	50	3	3,600
KDR-2244	2.44	22	50	3	3,600
KDR-2245	2.45	22	50	3	3,600
KDR-2246	2.46	22	50	3	3,600
KDR-2247	2.47	22	50	3	3,600
KDR-2248	2.48	22	50	3	3,600
KDR-2249	2.49	22	50	3	3,600
KDR-2250	2.5	22	50	3	3,600
KDR-2251	2.51	22	50	3	3,600
KDR-2252	2.52	22	50	3	3,600
KDR-2253	2.53	22	50	3	3,600
KDR-2254	2.54	22	50	3	3,600
KDR-2255	2.55	22	50	3	3,600
KDR-2256	2.56	22	50	3	3,600
KDR-2257	2.57	22	50	3	3,600
KDR-2258	2.58	22	50	3	3,600
KDR-2259	2.59	22	50	3	3,600
KDR-2260	2.6	22	50	3	3,600
KDR-2261	2.61	22	50	3	3,600
KDR-2262	2.62	22	50	3	3,600



# KDRLS-2

超硬ロングシャンクドリル  
Tungsten Carbide Long Shank Drill

■ 深堀加工用に全長を長くしました。  
Lengthened full length for deep processing.

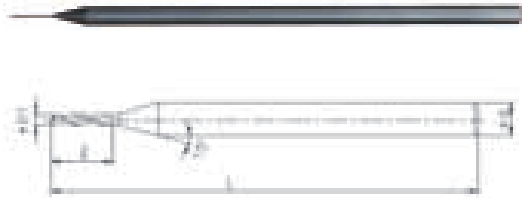

極超微粒子合金 Super Micro Grain Tungsten Carbide



刃径の許容差 Flute Diameter Tolerance  
D1 0~-0.01



柄径の許容差 Shank Diameter Tolerance  
d 0~-0.006



ネジレ角30° Twist Angle 30°



先端角度120° Point Angle 120°

● 切削条件表はP196に記載 単位[寸法: mm/価格: 円]  
● Cutting conditions are recommended on page 196. Unit [size: mm/Retail Price: JPY]

品番 Code No.	刃径 D1 Flute Diameter	刃長 ℓ Flute Length	全長 L Total Length	柄径 d Shank Diameter	標準価格 Retail Price
KDRLS-203002	0.3	2	100	3	9,400
KDRLS-203005	0.3	5	100	3	10,000
KDRLS-203502	0.35	2	100	3	9,400
KDRLS-203503	0.35	5	100	3	10,000
KDRLS-204003	0.4	3	100	3	9,400
KDRLS-204006	0.4	6	100	3	10,000
KDRLS-204503	0.45	3	100	3	9,400
KDRLS-204506	0.45	6	100	3	10,000
KDRLS-205003	0.5	3	100	3	8,700
KDRLS-205006	0.5	6	100	3	9,400
KDRLS-205503	0.55	3	100	3	8,700
KDRLS-205506	0.55	6	100	3	9,400
KDRLS-206003	0.6	3	100	3	8,700
KDRLS-206006	0.6	6	100	3	9,400
KDRLS-206503	0.65	3	100	3	8,700
KDRLS-206506	0.65	6	100	3	9,400
KDRLS-207004	0.7	4	100	3	8,700
KDRLS-207008	0.7	8	100	3	9,400
KDRLS-207504	0.75	4	100	3	8,700
KDRLS-207508	0.75	8	100	3	9,400

品番 Code No.	刃径 D1 Flute Diameter	刃長 ℓ Flute Length	全長 L Total Length	柄径 d Shank Diameter	標準価格 Retail Price
KDRLS-208004	0.8	4	100	3	8,700
KDRLS-208008	0.8	8	100	3	9,400
KDRLS-208504	0.85	4	100	3	8,700
KDRLS-208508	0.85	8	100	3	9,400
KDRLS-209004	0.9	4	100	3	8,700
KDRLS-209008	0.9	8	100	3	9,400
KDRLS-209504	0.95	4	100	3	8,700
KDRLS-209508	0.95	8	100	3	9,400
KDRLS-210005	1	5	100	3	8,400
KDRLS-210010	1	10	100	3	9,000
KDRLS-210505	1.05	5	100	3	8,400
KDRLS-210510	1.05	10	100	3	9,000
KDRLS-211005	1.1	5	100	3	8,400
KDRLS-211010	1.1	10	100	3	9,000
KDRLS-211505	1.15	5	100	3	8,400
KDRLS-211510	1.15	10	100	3	9,000
KDRLS-212005	1.2	5	100	3	8,400
KDRLS-212010	1.2	10	100	3	9,000
KDRLS-212505	1.25	5	100	3	8,400
KDRLS-212510	1.25	10	100	3	9,000
KDRLS-213005	1.3	5	100	3	8,400
KDRLS-213010	1.3	10	100	3	9,000
KDRLS-213505	1.35	5	100	3	8,400
KDRLS-213510	1.35	10	100	3	9,000
KDRLS-214005	1.4	5	100	3	8,400
KDRLS-214010	1.4	10	100	3	9,000
KDRLS-214505	1.45	5	100	3	8,400
KDRLS-214510	1.45	10	100	3	9,000
KDRLS-215005	1.5	5	100	3	8,400
KDRLS-215010	1.5	10	100	3	9,000
KDRLS-215505	1.55	5	100	3	8,400
KDRLS-215510	1.55	10	100	3	9,000
KDRLS-216007	1.6	7	100	3	8,700
KDRLS-216015	1.6	15	100	3	9,500
KDRLS-216507	1.65	7	100	3	8,700
KDRLS-216515	1.65	15	100	3	9,500
KDRLS-217007	1.7	7	100	3	8,700
KDRLS-217015	1.7	15	100	3	9,500
KDRLS-217507	1.75	7	100	3	8,700
KDRLS-217515	1.75	15	100	3	9,500
KDRLS-218007	1.8	7	100	3	8,700
KDRLS-218015	1.8	15	100	3	9,500
KDRLS-218507	1.85	7	100	3	8,700
KDRLS-218515	1.85	15	100	3	9,500
KDRLS-219007	1.9	7	100	3	8,700
KDRLS-219015	1.9	15	100	3	9,500
KDRLS-219507	1.95	7	100	3	8,700
KDRLS-219515	1.95	15	100	3	9,500

超硬製品

Tungsten Carbide



# KDR-DLC

超硬ルーマ型ドリル DLC  
Tungsten Carbide 2 Flutes Micro Drill DLC Coating



- 刃径0.03及び0.04の形状  
●Shape of Flute Diameter 0.03 and 0.04

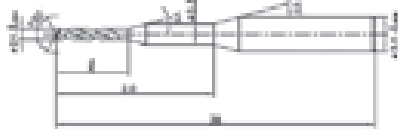

- 刃径0.05以上の形状  
●Shape of Flute Diameter more than 0.05



超微粒子合金 Micro Grain Tungsten Carbide



刃径の許容差 Flute Diameter Tolerance  
D1 0~-0.004



柄径の許容差 Shank Diameter Tolerance  
d 0~-0.006



ネジレ角30° Twist Angle 30°



先端角度120° Point Angle 120°

DLCコート

DLCコート DLC Coating

- 切削条件表はP196に記載 単位[寸法:mm/価格:円]  
●Cutting conditions are recommended on page 196. Unit [size:mm/Retail Price:JPY]

品番 Code No.	刃径 D1 Flute Diameter	刃長 ℓ Flute Length	全長 L Total Length	柄径 d Shank Diameter	標準価格 Retail Price
KDR-DLC-2008	0.08	0.8	38	3	9,870
KDR-DLC-2009	0.09	0.9	38	3	9,000
KDR-DLC-2010	0.1	1.2	38	3	7,540
KDR-DLC-2011	0.11	1.2	38	3	7,540
KDR-DLC-2012	0.12	1.4	38	3	7,540
KDR-DLC-2013	0.13	1.4	38	3	7,540
KDR-DLC-2014	0.14	1.4	38	3	7,540
KDR-DLC-2015	0.15	1.8	38	3	7,540
KDR-DLC-2016	0.16	1.8	38	3	7,540
KDR-DLC-2017	0.17	1.8	38	3	7,540
KDR-DLC-2018	0.18	2.1	38	3	6,670
KDR-DLC-2019	0.19	2.1	38	3	6,670
KDR-DLC-2020	0.2	2.4	38	3	6,670
KDR-DLC-2021	0.21	2.4	38	3	6,670
KDR-DLC-2022	0.22	2.6	38	3	6,670
KDR-DLC-2023	0.23	2.6	38	3	6,670
KDR-DLC-2024	0.24	2.6	38	3	6,670
KDR-DLC-2025	0.25	3	38	3	6,670
KDR-DLC-2026	0.26	3	38	3	6,670
KDR-DLC-2027	0.27	3	38	3	6,670

品番 Code No.	刃径 D1 Flute Diameter	刃長 ℓ Flute Length	全長 L Total Length	柄径 d Shank Diameter	標準価格 Retail Price
KDR-DLC-2028	0.28	3.3	38	3	6,670
KDR-DLC-2029	0.29	3.3	38	3	6,670
KDR-DLC-2030	0.3	5	38	3	6,670
KDR-DLC-2031	0.31	5	38	3	5,670
KDR-DLC-2032	0.32	5	38	3	5,670
KDR-DLC-2033	0.33	5	38	3	5,670
KDR-DLC-2034	0.34	5	38	3	5,670
KDR-DLC-2035	0.35	5	38	3	5,670
KDR-DLC-2036	0.36	5	38	3	5,670
KDR-DLC-2037	0.37	5	38	3	5,670
KDR-DLC-2038	0.38	5	38	3	5,670
KDR-DLC-2039	0.39	5	38	3	5,670
KDR-DLC-2040	0.4	6	38	3	5,670
KDR-DLC-2041	0.41	6	38	3	5,670
KDR-DLC-2042	0.42	6	38	3	5,670
KDR-DLC-2043	0.43	6	38	3	5,670
KDR-DLC-2044	0.44	6	38	3	5,670
KDR-DLC-2045	0.45	6	38	3	5,670
KDR-DLC-2046	0.46	6	38	3	5,670
KDR-DLC-2047	0.47	6	38	3	5,670
KDR-DLC-2048	0.48	6	38	3	5,670
KDR-DLC-2049	0.49	6	38	3	5,670
KDR-DLC-2050	0.5	6	38	3	5,670
KDR-DLC-2051	0.51	6	38	3	5,670
KDR-DLC-2052	0.52	6	38	3	5,670
KDR-DLC-2053	0.53	6	38	3	5,670
KDR-DLC-2054	0.54	6	38	3	5,670
KDR-DLC-2055	0.55	6	38	3	5,670
KDR-DLC-2056	0.56	6	38	3	5,670
KDR-DLC-2057	0.57	6	38	3	5,670
KDR-DLC-2058	0.58	6	38	3	5,670
KDR-DLC-2059	0.59	6	38	3	5,670
KDR-DLC-2060	0.6	7	38	3	5,670
KDR-DLC-2061	0.61	7	38	3	5,670
KDR-DLC-2062	0.62	7	38	3	5,670
KDR-DLC-2063	0.63	7	38	3	5,670
KDR-DLC-2064	0.64	7	38	3	5,670
KDR-DLC-2065	0.65	7	38	3	5,670
KDR-DLC-2066	0.66	7	38	3	5,670
KDR-DLC-2067	0.67	7	38	3	5,670
KDR-DLC-2068	0.68	7	38	3	5,670
KDR-DLC-2069	0.69	7	38	3	5,670
KDR-DLC-2070	0.7	8	38	3	5,670
KDR-DLC-2071	0.71	8	38	3	5,670
KDR-DLC-2072	0.72	8	38	3	5,670
KDR-DLC-2073	0.73	8	38	3	5,670
KDR-DLC-2074	0.74	8	38	3	5,670
KDR-DLC-2075	0.75	8	38	3	5,670





# KDR-90

超硬ルーマ型ドリル  
Tungsten Carbide 2 Flutes Micro Drill

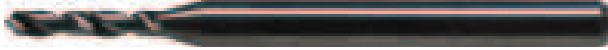

超微粒子合金 Micro Grain Tungsten Carbide



刃径の許容差 Flute Diameter Tolerance  
D1 0~-0.004



柄径の許容差 Shank Diameter Tolerance  
d 0~-0.006



ネジレ角30° Twist Angle 30°



先端角度90° Point Angle 90°

●切削条件表はP196に記載

単位[寸法:mm/価格:円]

●Cutting conditions are recommended on page 196.

Unit [size:mm/Retail Price:JPY]

品番 Code No.	刃径 D1 Flute Diameter	刃長 ℓ Flute Length	全長 L Total Length	柄径 d Shank Diameter	標準価格 Retail Price
KDR-90-2050	0.5	5	38	3	3,590
KDR-90-2051	0.51	5	38	3	3,590
KDR-90-2052	0.52	5	38	3	3,590
KDR-90-2053	0.53	5	38	3	3,590
KDR-90-2054	0.54	5	38	3	3,590
KDR-90-2055	0.55	5	38	3	3,590
KDR-90-2056	0.56	5	38	3	3,590
KDR-90-2057	0.57	5	38	3	3,590
KDR-90-2058	0.58	5	38	3	3,590
KDR-90-2059	0.59	5	38	3	3,590
KDR-90-2060	0.6	6	38	3	3,590
KDR-90-2061	0.61	6	38	3	3,590
KDR-90-2062	0.62	6	38	3	3,590
KDR-90-2063	0.63	6	38	3	3,590
KDR-90-2064	0.64	6	38	3	3,590
KDR-90-2065	0.65	6	38	3	3,590
KDR-90-2066	0.66	6	38	3	3,590
KDR-90-2067	0.67	6	38	3	3,590
KDR-90-2068	0.68	6	38	3	3,590
KDR-90-2069	0.69	6	38	3	3,590

品番 Code No.	刃径 D1 Flute Diameter	刃長 ℓ Flute Length	全長 L Total Length	柄径 d Shank Diameter	標準価格 Retail Price
KDR-90-2070	0.7	7	38	3	3,590
KDR-90-2071	0.71	7	38	3	3,590
KDR-90-2072	0.72	7	38	3	3,590
KDR-90-2073	0.73	7	38	3	3,590
KDR-90-2074	0.74	7	38	3	3,590
KDR-90-2075	0.75	7	38	3	3,590
KDR-90-2076	0.76	7	38	3	3,590
KDR-90-2077	0.77	7	38	3	3,590
KDR-90-2078	0.78	7	38	3	3,590
KDR-90-2079	0.79	7	38	3	3,590
KDR-90-2080	0.8	7	38	3	3,590
KDR-90-2081	0.81	7	38	3	3,590
KDR-90-2082	0.82	7	38	3	3,590
KDR-90-2083	0.83	7	38	3	3,590
KDR-90-2084	0.84	7	38	3	3,590
KDR-90-2085	0.85	7	38	3	3,590
KDR-90-2086	0.86	7	38	3	3,590
KDR-90-2087	0.87	7	38	3	3,590
KDR-90-2088	0.88	7	38	3	3,590
KDR-90-2089	0.89	7	38	3	3,590
KDR-90-2090	0.9	7	38	3	3,590
KDR-90-2091	0.91	7	38	3	3,590
KDR-90-2092	0.92	7	38	3	3,590
KDR-90-2093	0.93	7	38	3	3,590
KDR-90-2094	0.94	7	38	3	3,590
KDR-90-2095	0.95	7	38	3	3,590
KDR-90-2096	0.96	7	38	3	3,590
KDR-90-2097	0.97	7	38	3	3,590
KDR-90-2098	0.98	7	38	3	3,590
KDR-90-2099	0.99	7	38	3	3,590
KDR-90-2100	1	9	38	3	3,590
KDR-90-2105	1.05	9	38	3	3,590
KDR-90-2110	1.1	9	38	3	3,590
KDR-90-2115	1.15	9	38	3	3,590
KDR-90-2120	1.2	9	38	3	3,590
KDR-90-2125	1.25	9	38	3	3,590
KDR-90-2130	1.3	9	38	3	3,590
KDR-90-2135	1.35	9	38	3	3,590
KDR-90-2140	1.4	9	38	3	3,590
KDR-90-2145	1.45	9	38	3	3,590
KDR-90-2150	1.5	9	38	3	3,590
KDR-90-2155	1.55	9	38	3	3,590
KDR-90-2160	1.6	21	50	3	4,070
KDR-90-2165	1.65	21	50	3	4,070
KDR-90-2170	1.7	21	50	3	4,070
KDR-90-2175	1.75	21	50	3	4,070
KDR-90-2180	1.8	21	50	3	4,070
KDR-90-2185	1.85	21	50	3	4,070



# KDR-F

超硬ルーマ型ドリル  
Tungsten Carbide 2 Flutes Micro Drill

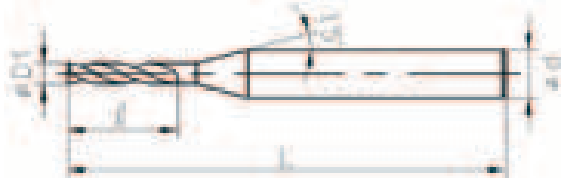

超微粒子合金 Micro Grain Tungsten Carbide



刃径の許容差 Flute Diameter Tolerance  
D1 0~-0.004



柄径の許容差 Shank Diameter Tolerance  
d 0~-0.006



ネジレ角30° Twist Angle 30°



先端角度180° Point Angle 180°

●切削条件表はP196に記載

単位[寸法:mm/価格:円]

●Cutting conditions are recommended on page 196.

Unit [size:mm/Retail Price:JPY]

品番 Code No.	刃径 D1 Flute Diameter	刃長 ℓ Flute Length	全長 L Total Length	柄径 d Shank Diameter	標準価格 Retail Price
KDR-F-2050	0.5	5	38	3	3,590
KDR-F-2051	0.51	5	38	3	3,590
KDR-F-2052	0.52	5	38	3	3,590
KDR-F-2053	0.53	5	38	3	3,590
KDR-F-2054	0.54	5	38	3	3,590
KDR-F-2055	0.55	5	38	3	3,590
KDR-F-2056	0.56	5	38	3	3,590
KDR-F-2057	0.57	5	38	3	3,590
KDR-F-2058	0.58	5	38	3	3,590
KDR-F-2059	0.59	5	38	3	3,590
KDR-F-2060	0.6	6	38	3	3,590
KDR-F-2061	0.61	6	38	3	3,590
KDR-F-2062	0.62	6	38	3	3,590
KDR-F-2063	0.63	6	38	3	3,590
KDR-F-2064	0.64	6	38	3	3,590
KDR-F-2065	0.65	6	38	3	3,590
KDR-F-2066	0.66	6	38	3	3,590
KDR-F-2067	0.67	6	38	3	3,590
KDR-F-2068	0.68	6	38	3	3,590
KDR-F-2069	0.69	6	38	3	3,590

品番 Code No.	刃径 D1 Flute Diameter	刃長 ℓ Flute Length	全長 L Total Length	柄径 d Shank Diameter	標準価格 Retail Price
KDR-F-2070	0.7	7	38	3	3,590
KDR-F-2071	0.71	7	38	3	3,590
KDR-F-2072	0.72	7	38	3	3,590
KDR-F-2073	0.73	7	38	3	3,590
KDR-F-2074	0.74	7	38	3	3,590
KDR-F-2075	0.75	7	38	3	3,590
KDR-F-2076	0.76	7	38	3	3,590
KDR-F-2077	0.77	7	38	3	3,590
KDR-F-2078	0.78	7	38	3	3,590
KDR-F-2079	0.79	7	38	3	3,590
KDR-F-2080	0.8	7	38	3	3,590
KDR-F-2081	0.81	7	38	3	3,590
KDR-F-2082	0.82	7	38	3	3,590
KDR-F-2083	0.83	7	38	3	3,590
KDR-F-2084	0.84	7	38	3	3,590
KDR-F-2085	0.85	7	38	3	3,590
KDR-F-2086	0.86	7	38	3	3,590
KDR-F-2087	0.87	7	38	3	3,590
KDR-F-2088	0.88	7	38	3	3,590
KDR-F-2089	0.89	7	38	3	3,590
KDR-F-2090	0.9	7	38	3	3,590
KDR-F-2091	0.91	7	38	3	3,590
KDR-F-2092	0.92	7	38	3	3,590
KDR-F-2093	0.93	7	38	3	3,590
KDR-F-2094	0.94	7	38	3	3,590
KDR-F-2095	0.95	7	38	3	3,590
KDR-F-2096	0.96	7	38	3	3,590
KDR-F-2097	0.97	7	38	3	3,590
KDR-F-2098	0.98	7	38	3	3,590
KDR-F-2099	0.99	7	38	3	3,590
KDR-F-2100	1	9	38	3	3,590
KDR-F-2105	1.05	9	38	3	3,590
KDR-F-2110	1.1	9	38	3	3,590
KDR-F-2115	1.15	9	38	3	3,590
KDR-F-2120	1.2	9	38	3	3,590
KDR-F-2125	1.25	9	38	3	3,590
KDR-F-2130	1.3	9	38	3	3,590
KDR-F-2135	1.35	9	38	3	3,590
KDR-F-2140	1.4	9	38	3	3,590
KDR-F-2145	1.45	9	38	3	3,590
KDR-F-2150	1.5	9	38	3	3,590
KDR-F-2155	1.55	9	38	3	3,590
KDR-F-2160	1.6	21	50	3	4,070
KDR-F-2165	1.65	21	50	3	4,070
KDR-F-2170	1.7	21	50	3	4,070
KDR-F-2175	1.75	21	50	3	4,070
KDR-F-2180	1.8	21	50	3	4,070
KDR-F-2185	1.85	21	50	3	4,070

超硬製品

Tungsten Carbide







# KCD-60

超硬センタードリル・ノンコート  
Tungsten Carbide 2 Flutes Drill(Turbo Drill)

- 先端径、太径ともネジレ角30°  
Twist Angle 30° at both Small Flute Diameter and Large Flute Diameter
- バリを抑制し高能率加工が可能。  
Possible to cut by High Efficiency without Bur

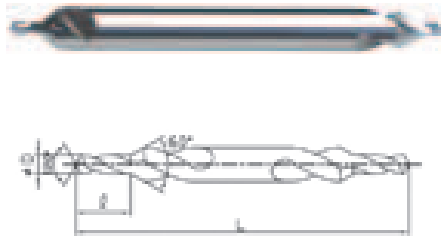

**MG** 超微粒子合金 Micro Grain Tungsten Carbide

刃径の許容差 Flute Diameter Tolerance  
D 0~-0.01

柄径の許容差 Shank Diameter Tolerance  
d=3 0~-0.006  
3 < d ≤ 6 0~-0.008  
d=8 0~-0.009

ネジレ角30° 先端径、太径とも  
Twist Angle 30°  
Both Small Flute Diameter and Large Flute Diameter

先端角度120° Point Angle 120°

●切削条件表はP198に記載 単位[寸法:mm/価格:円]  
●Cutting conditions are recommended on page 198. Unit [size:mm/Retail Price:JPY]

品番 Code No.	刃径 D Flute Diameter	刃長 ℓ Flute Length	全長 L Total Length	柄径 d Shank Diameter	標準価格 Retail Price
KCD-6003	0.3	0.3	60	3	9,300
KCD-6004	0.4	0.5	60	3	9,000
KCD-6005	0.5	0.6	60	3	8,500
KCD-6008	0.8	1	60	3	7,200
KCD-6010	1	1.3	60	4	6,400
KCD-6012	1.2	1.5	60	4	6,400
KCD-6015	1.5	1.9	60	4	6,400
KCD-6020	2	2.6	60	6	9,000
KCD-6020L	2	2.6	150	6	15,200
KCD-6025	2.5	3.2	60	6	9,000
KCD-6025L	2.5	3.2	150	6	15,200
KCD-6030	3	3.9	70	8	13,600
KCD-6030L	3	3.9	150	8	19,500

# KCDA-60

超硬センタードリル・TiAlN  
Tungsten Carbide 2 Flutes Drill(Turbo Drill)  
TiAlN Coating

- 先端径、太径ともネジレ角30°  
Twist Angle 30° at both Small Flute Diameter and Large Flute Diameter
- バリを抑制し高能率加工が可能。  
Possible to cut by High Efficiency without Bur

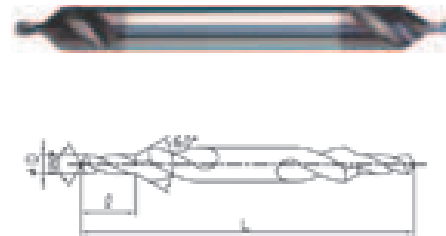

**MG** 超微粒子合金 Micro Grain Tungsten Carbide

刃径の許容差 Flute Diameter Tolerance  
D 0~-0.01

柄径の許容差 Shank Diameter Tolerance  
d=3 0~-0.006  
3 < d ≤ 6 0~-0.008  
d=8 0~-0.009

ネジレ角30° 先端径、太径とも  
Twist Angle 30°  
Both Small Flute Diameter and Large Flute Diameter

先端角度120° Point Angle 120°

**TiAlNコート** TiAlN コート TiAlN Coating

●切削条件表はP198に記載 単位[寸法:mm/価格:円]  
●Cutting conditions are recommended on page 198. Unit [size:mm/Retail Price:JPY]

品番 Code No.	刃径 D Flute Diameter	刃長 ℓ Flute Length	全長 L Total Length	柄径 d Shank Diameter	標準価格 Retail Price
KCDA-6003	0.3	0.3	60	3	10,600
KCDA-6004	0.4	0.5	60	3	10,300
KCDA-6005	0.5	0.6	60	3	10,000
KCDA-6008	0.8	1	60	3	8,500
KCDA-6010	1	1.3	60	4	7,900
KCDA-6012	1.2	1.5	60	4	7,900
KCDA-6015	1.5	1.9	60	4	7,900
KCDA-6020	2	2.6	60	6	10,600
KCDA-6020L	2	2.6	150	6	18,700
KCDA-6025	2.5	3.2	60	6	10,600
KCDA-6025L	2.5	3.2	150	6	18,700
KCDA-6030	3	3.9	70	8	15,700
KCDA-6030L	3	3.9	150	8	23,500

# KCD-90

超硬センタードリル・ノンコート  
Tungsten Carbide 2 Flutes Drill (Turbo Drill)

- 先端径、太径ともネジレ角30°  
Twist Angle 30° at both Small Flute Diameter and Large Flute Diameter
- バリを抑制し高能率加工が可能。  
Possible to cut by High Efficiency without Bur

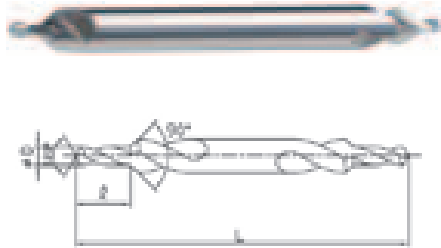

超微粒子合金 Micro Grain Tungsten Carbide



刃径の許容差 Flute Diameter Tolerance  
D 0~-0.01



柄径の許容差 Shank Diameter Tolerance  
d=3 0~-0.006  
3 < d ≤ 6 0~-0.008  
d=8 0~-0.009



ネジレ角30° 先端径、太径とも  
Twist Angle 30°  
Both Small Flute Diameter and Large Flute Diameter



先端角度120° Point Angle 120°

●切削条件表はP198に記載 単位[寸法:mm/価格:円]  
●Cutting conditions are recommended on page 198. Unit [size:mm/Retail Price:JPY]

品番 Code No.	刃径 D Flute Diameter	刃長 ℓ Flute Length	全長 L Total Length	柄径 d Shank Diameter	標準価格 Retail Price
KCD-9003	0.3	0.3	60	3	9,300
KCD-9004	0.4	0.5	60	3	9,000
KCD-9005	0.5	0.6	60	3	8,500
KCD-9008	0.8	1	60	3	7,200
KCD-9010	1	1.3	60	4	6,400
KCD-9012	1.2	1.5	60	4	6,400
KCD-9015	1.5	1.9	60	4	6,400
KCD-9020	2	2.6	60	6	9,000
KCD-9020L	2	2.6	150	6	15,200
KCD-9025	2.5	3.2	60	6	9,000
KCD-9025L	2.5	3.2	150	6	15,200
KCD-9030	3	3.9	70	8	13,600
KCD-9030L	3	3.9	150	8	19,500

# KCDA-90

超硬センタードリル・TiAlN  
Tungsten Carbide 2 Flutes Drill (Turbo Drill)  
TiAlN Coating

- 先端径、太径ともネジレ角30°  
Twist Angle 30° at both Small Flute Diameter and Large Flute Diameter
- バリを抑制し高能率加工が可能。  
Possible to cut by High Efficiency without Bur

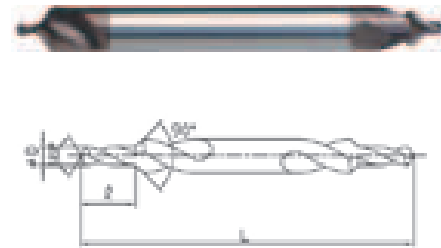

超微粒子合金 Micro Grain Tungsten Carbide



刃径の許容差 Flute Diameter Tolerance  
D 0~-0.01



柄径の許容差 Shank Diameter Tolerance  
d=3 0~-0.006  
3 < d ≤ 6 0~-0.008  
d=8 0~-0.009



ネジレ角30° 先端径、太径とも  
Twist Angle 30°  
Both Small Flute Diameter and Large Flute Diameter



先端角度120° Point Angle 120°



TiAlNコート TiAlN Coating

●切削条件表はP198に記載 単位[寸法:mm/価格:円]  
●Cutting conditions are recommended on page 198. Unit [size:mm/Retail Price:JPY]

品番 Code No.	刃径 D Flute Diameter	刃長 ℓ Flute Length	全長 L Total Length	柄径 d Shank Diameter	標準価格 Retail Price
KCDA-9003	0.3	0.3	60	3	10,600
KCDA-9004	0.4	0.5	60	3	10,300
KCDA-9005	0.5	0.6	60	3	10,000
KCDA-9008	0.8	1	60	3	8,500
KCDA-9010	1	1.3	60	4	7,900
KCDA-9012	1.2	1.5	60	4	7,900
KCDA-9015	1.5	1.9	60	4	7,900
KCDA-9020	2	2.6	60	6	10,600
KCDA-9020L	2	2.6	150	6	18,700
KCDA-9025	2.5	3.2	60	6	10,600
KCDA-9025L	2.5	3.2	150	6	18,700
KCDA-9030	3	3.9	70	8	15,700
KCDA-9030L	3	3.9	150	8	23,500







# KDD-2

## 超硬段付ドリル 90°面取刃付 Tungsten Carbide 2 Flutes Step Drill

- 先端径、太径ともネジレ角30°  
Twist Angle 30° at both Small Flute Diameter and Large Flute Diameter
- 刃径を0.05とびにラインナップ。  
Line-upped at pitch 0.05

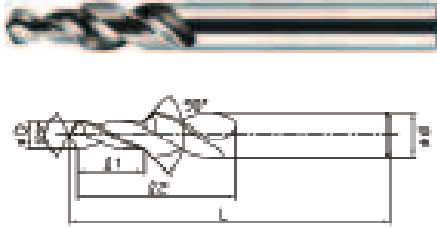

超微粒子合金 Micro Grain Tungsten Carbide



刃径の許容差 Flute Diameter Tolerance  
D 0~-0.01



柄径の許容差 Shank Diameter Tolerance  
d=3 0~-0.006  
3<d≤6 0~-0.008  
d=8 0~-0.009



ネジレ角30° 先端径、太径とも  
Twist Angle 30°  
Both Small Flute Diameter and Large Flute Diameter



先端角度120° Point Angle 120°  
面取角度 90° (両角) ±30°

- 切削条件表はP200に記載
- Cutting conditions are recommended on page 200.

単位[寸法:mm/価格:円]

Unit [size:mm/Retail Price:JPY]

品番 Code No.	刃径 D Flute Diameter	刃長 ℓ1 Flute Length	溝長 ℓ2 Groove Length	全長 L Total Length	柄径 d Shank Diameter	適用ネジ Applicable Thread	標準価格 Retail Price
KDD-205002	0.5	2	8	50	3	-	7,900
KDD-205005	0.5	5	12	50	3	-	9,000
KDD-205502	0.55	2	8	50	3	-	7,900
KDD-205505	0.55	5	12	50	3	-	9,000
KDD-206002	0.6	2	8	50	3	-	7,900
KDD-206005	0.6	5	12	50	3	-	9,000
KDD-206502	0.65	2	8	50	3	-	7,900
KDD-206505	0.65	5	12	50	3	-	9,000
KDD-207002	0.7	2	8	50	3	-	7,900
KDD-207005	0.7	5	12	50	3	-	9,000
KDD-207503	0.75	3	10	50	3	M1×0.25	7,900
KDD-207506	0.75	6	15	50	3	M1×0.25	9,000
KDD-208003	0.8	3	10	50	3	M1×0.2	7,500
KDD-208006	0.8	6	15	50	3	M1×0.2	8,500
KDD-208503	0.85	3	10	50	3	M1.1×0.25	7,500
KDD-208506	0.85	6	15	50	3	M1.1×0.25	8,500
KDD-209003	0.9	3	10	50	3	M1.1×0.2	7,500
KDD-209006	0.9	6	15	50	3	M1.1×0.2	8,500
KDD-209503	0.95	3	10	50	3	M1.2×0.25	7,500
KDD-209506	0.95	6	15	50	3	M1.2×0.25	8,500
KDD-210003	1	3	10	50	3	M1.2×0.2	7,200
KDD-210006	1	6	15	50	3	M1.2×0.2	7,900

品番 Code No.	刃径 D Flute Diameter	刃長 ℓ1 Flute Length	溝長 ℓ2 Groove Length	全長 L Total Length	柄径 d Shank Diameter	適用ネジ Applicable Thread	標準価格 Retail Price
KDD-210503	1.05	3	10	50	3	-	7,200
KDD-210506	1.05	6	15	50	3	-	7,900
KDD-211003	1.1	3	10	50	3	M1.4×0.3	7,200
KDD-211006	1.1	6	15	50	3	M1.4×0.3	7,900
KDD-211503	1.15	3	10	50	3	-	7,200
KDD-211506	1.15	6	15	50	3	-	7,900
KDD-212003	1.2	3	10	50	3	M1.4×0.2	7,200
KDD-212006	1.2	6	15	50	3	M1.4×0.2	7,900
KDD-212503	1.25	3	10	50	3	M1.6×0.35	7,200
KDD-212506	1.25	6	15	50	3	M1.6×0.35	7,900
KDD-213003	1.3	3	10	50	3	-	7,200
KDD-213006	1.3	6	15	50	3	-	7,900
KDD-213503	1.35	3	10	50	3	-	7,200
KDD-213506	1.35	6	15	50	3	-	7,900
KDD-214003	1.4	3	10	50	3	M1.6×0.2	7,200
KDD-214006	1.4	6	15	50	3	M1.7×0.3	7,900
KDD-214503	1.45	3	10	50	3	-	7,200
KDD-214506	1.45	6	15	50	3	-	7,900
KDD-215003	1.5	3	10	50	3	M1.7×0.2	7,200
KDD-215006	1.5	6	15	50	3	M1.7×0.2	7,900
KDD-215503	1.55	3	10	50	3	-	7,200
KDD-215506	1.55	6	15	50	3	-	7,900
KDD-216005	1.6	5	15	60	4	M1.8×0.2	8,500
KDD-216010	1.6	10	20	60	4	M1.8×0.2	9,600
KDD-216505	1.65	5	15	60	4	-	8,500
KDD-216510	1.65	10	20	60	4	-	9,600
KDD-217005	1.7	5	15	60	4	-	8,500
KDD-217010	1.7	10	20	60	4	-	9,600
KDD-217505	1.75	5	15	60	4	M2×0.25	8,500
KDD-217510	1.75	10	20	60	4	M2.2×0.45	9,600
KDD-218005	1.8	5	15	60	4	-	8,500
KDD-218010	1.8	10	20	60	4	-	9,600
KDD-218505	1.85	5	15	60	4	-	8,500
KDD-218510	1.85	10	20	60	4	-	9,600
KDD-219005	1.9	5	15	60	4	-	8,500
KDD-219010	1.9	10	20	60	4	-	9,600
KDD-219505	1.95	5	15	60	4	M2.2×0.25	8,500
KDD-219510	1.95	10	20	60	4	M2.3×0.35	9,600
KDD-220005	2	5	15	60	4	-	8,500
KDD-220010	2	10	20	60	4	-	9,600
KDD-220505	2.05	5	15	60	4	-	8,500
KDD-220510	2.05	10	20	60	4	-	9,600
KDD-221006	2.1	6	15	60	4	M2.5×0.45	8,500
KDD-221012	2.1	12	20	60	4	M2.5×0.45	9,600
KDD-221506	2.15	6	15	60	4	-	8,500
KDD-221512	2.15	12	20	60	4	-	9,600
KDD-222006	2.2	6	15	60	4	M2.5×0.35	8,500
KDD-222012	2.2	12	20	60	4	M2.6×0.45	9,600

# KDD-2

品番 Code No.	刃径 D Flute Diameter	刃長 ℓ1 Flute Length	溝長 ℓ2 Groove Length	全長 L Total Length	柄径 d Shank Diameter	適用ネジ Applicable Thread	標準価格 Retail Price
KDD-222506	2.25	6	15	60	4		8,500
KDD-222512	2.25	12	20	60	4		9,600
KDD-223006	2.3	6	15	60	4		8,500
KDD-223012	2.3	12	20	60	4		9,600
KDD-223506	2.35	6	15	60	4		8,500
KDD-223512	2.35	12	20	60	4		9,600
KDD-224006	2.4	6	15	60	4	M2.6×0.35	8,500
KDD-224012	2.4	12	20	60	4	M2.6×0.35	9,600
KDD-224506	2.45	6	15	60	4		8,500
KDD-224512	2.45	12	20	60	4		9,600
KDD-225006	2.5	6	15	70	6	M3×0.5	10,600
KDD-225012	2.5	12	20	70	6	M3×0.5	12,500
KDD-225506	2.55	6	15	70	6		10,600
KDD-225512	2.55	12	20	70	6		12,500
KDD-226006	2.6	6	15	70	6		10,600
KDD-226012	2.6	12	20	70	6		12,500
KDD-226510	2.65	10	25	70	6	M3×0.35	10,600
KDD-226520	2.65	20	35	70	6	M3×0.35	12,500
KDD-227010	2.7	10	25	70	6		10,600
KDD-227020	2.7	20	35	70	6		12,500
KDD-227510	2.75	10	25	70	6		10,600
KDD-227520	2.75	20	35	70	6		12,500
KDD-228010	2.8	10	25	70	6		10,600
KDD-228020	2.8	20	35	70	6		12,500
KDD-228510	2.85	10	25	70	6		10,600
KDD-228520	2.85	20	35	70	6		12,500
KDD-229010	2.9	10	25	70	6		10,600
KDD-229020	2.9	20	35	70	6		12,500
KDD-229510	2.95	10	25	70	6		10,600
KDD-229520	2.95	20	35	70	6		12,500
KDD-230010	3	10	25	70	6	M3.5×0.6	10,600
KDD-230020	3	20	35	70	6	M3.5×0.6	12,500
KDD-230510	3.05	10	25	70	6		10,600
KDD-230520	3.05	20	35	70	6		12,500
KDD-231010	3.1	10	25	70	6		10,600
KDD-231020	3.1	20	35	70	6		12,500
KDD-231510	3.15	10	25	70	6	M3.5×0.35	10,600
KDD-231520	3.15	20	35	70	6	M3.5×0.35	12,500
KDD-232010	3.2	10	25	70	6		10,600
KDD-232020	3.2	20	35	70	6		12,500
KDD-232510	3.25	10	25	70	6		10,600
KDD-232520	3.25	20	35	70	6		12,500
KDD-233010	3.3	10	25	70	6	M4×0.7	10,600
KDD-233020	3.3	20	35	70	6	M4×0.7	12,500
KDD-233510	3.35	10	25	70	6		10,600
KDD-233520	3.35	20	35	70	6		12,500
KDD-234010	3.4	10	25	70	6		10,600
KDD-234020	3.4	20	35	70	6		12,500

品番 Code No.	刃径 D Flute Diameter	刃長 ℓ1 Flute Length	溝長 ℓ2 Groove Length	全長 L Total Length	柄径 d Shank Diameter	適用ネジ Applicable Thread	標準価格 Retail Price
KDD-234510	3.45	10	25	70	6		10,600
KDD-234520	3.45	20	35	70	6		12,500
KDD-235010	3.5	10	25	70	6	M4×0.5	10,600
KDD-235020	3.5	20	35	70	6	M4×0.5	12,500
KDD-235510	3.55	10	25	70	6		10,600
KDD-235520	3.55	20	35	70	6		12,500
KDD-236010	3.6	10	25	70	6		10,600
KDD-236020	3.6	20	35	70	6		12,500
KDD-236510	3.65	10	25	70	6		10,600
KDD-236520	3.65	20	35	70	6		12,500
KDD-237010	3.7	10	25	70	6		10,600
KDD-237020	3.7	20	35	70	6		12,500
KDD-237510	3.75	10	25	70	6	M4.5×0.75	10,600
KDD-237520	3.75	20	35	70	6	M4.5×0.75	12,500
KDD-238010	3.8	10	25	70	6		10,600
KDD-238020	3.8	20	35	70	6		12,500
KDD-238510	3.85	10	25	70	6		10,600
KDD-238520	3.85	20	35	70	6		12,500
KDD-239010	3.9	10	25	70	6		10,600
KDD-239020	3.9	20	35	70	6		12,500
KDD-239510	3.95	10	25	70	6		10,600
KDD-239520	3.95	20	35	70	6		12,500
KDD-240010	4	10	25	80	8	M4.5×0.5	14,400
KDD-240020	4	20	35	80	8	M4.5×0.5	16,500
KDD-240510	4.05	10	25	80	8		14,400
KDD-240520	4.05	20	35	80	8		16,500
KDD-241010	4.1	10	25	80	8	M5×0.9	14,400
KDD-241020	4.1	20	35	80	8	M5×0.9	16,500
KDD-241510	4.15	10	25	80	8		14,400
KDD-241520	4.15	20	35	80	8		16,500
KDD-242010	4.2	10	25	80	8	M5×0.8	14,400
KDD-242020	4.2	20	35	80	8	M5×0.8	16,500
KDD-242510	4.25	10	25	80	8		14,400
KDD-242520	4.25	20	35	80	8		16,500
KDD-243010	4.3	10	25	80	8		14,400
KDD-243020	4.3	20	35	80	8		16,500
KDD-243510	4.35	10	25	80	8		14,400
KDD-243520	4.35	20	35	80	8		16,500
KDD-244010	4.4	10	25	80	8		14,400
KDD-244020	4.4	20	35	80	8		16,500
KDD-244510	4.45	10	25	80	8		14,400
KDD-244520	4.45	20	35	80	8		16,500
KDD-245010	4.5	10	25	80	8	M5×0.5	14,400
KDD-245020	4.5	20	35	80	8	M5×0.5	16,500
KDD-245510	4.55	10	25	80	8		14,400
KDD-245520	4.55	20	35	80	8		16,500
KDD-246010	4.6	10	25	80	8	M5.5×0.9	14,400
KDD-246020	4.6	20	35	80	8	M5.5×0.9	16,500

超硬製品

Tungsten Carbide



# KMSE-2

## 超硬ミニチュアエンドミル Tungsten Carbide Miniature Endmill

■刃径をΦ0.1~Φ3まで0.01とびにラインナップ  
Line-upped Φ0.1~Φ3 at pitch 0.01

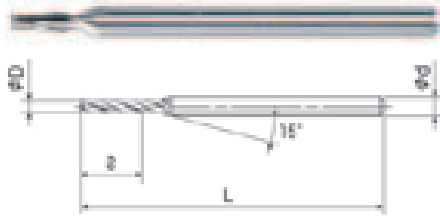

超微粒子合金 Micro Grain Tungsten Carbide



刃径の許容差 Flute Diameter Tolerance  
D 0~-0.01



柄径の許容差 Shank Diameter Tolerance  
d 0~-0.006



ネジレ角30° Twist Angle 30°



ピンカド Sharp Edge

●切削条件表はP201に記載  
●Cutting conditions are recommended on page 201.

単位[寸法: mm/価格: 円]

Unit [size: mm/Retail Price: JPY]

品番 Code No.	刃径 D Flute Diameter	刃長 ℓ Flute Length	全長 L Total Length	柄径 d Shank Diameter	標準価格 Retail Price
KMSE-2010	0.1	0.2	40	3	15,900
KMSE-2011	0.11	0.2	40	3	14,100
KMSE-2012	0.12	0.3	40	3	14,100
KMSE-2013	0.13	0.3	40	3	14,100
KMSE-2014	0.14	0.3	40	3	14,100
KMSE-2015	0.15	0.3	40	3	14,100
KMSE-2016	0.16	0.3	40	3	14,100
KMSE-2017	0.17	0.3	40	3	14,100
KMSE-2018	0.18	0.3	40	3	14,100
KMSE-2019	0.19	0.3	40	3	14,100
KMSE-2020	0.2	0.4	40	3	10,600
KMSE-2021	0.21	0.5	40	3	11,700
KMSE-2022	0.22	0.5	40	3	11,700
KMSE-2023	0.23	0.5	40	3	11,700
KMSE-2024	0.24	0.5	40	3	11,700
KMSE-2025	0.25	0.5	40	3	11,700
KMSE-2026	0.26	0.8	40	3	11,700
KMSE-2027	0.27	0.8	40	3	11,700
KMSE-2028	0.28	0.8	40	3	11,700
KMSE-2029	0.29	0.8	40	3	11,700
KMSE-2030	0.3	1	40	3	9,700
KMSE-2031	0.31	1	40	3	10,600

品番 Code No.	刃径 D Flute Diameter	刃長 ℓ Flute Length	全長 L Total Length	柄径 d Shank Diameter	標準価格 Retail Price
KMSE-2032	0.32	1	40	3	10,600
KMSE-2033	0.33	1	40	3	10,600
KMSE-2034	0.34	1	40	3	10,600
KMSE-2035	0.35	1	40	3	10,600
KMSE-2036	0.36	1	40	3	10,600
KMSE-2037	0.37	1	40	3	10,600
KMSE-2038	0.38	1	40	3	10,600
KMSE-2039	0.39	1	40	3	10,600
KMSE-2040	0.4	1	40	3	8,500
KMSE-2041	0.41	1	40	3	9,100
KMSE-2042	0.42	1	40	3	9,100
KMSE-2043	0.43	1	40	3	9,100
KMSE-2044	0.44	1	40	3	9,100
KMSE-2045	0.45	1	40	3	9,100
KMSE-2046	0.46	1	40	3	9,100
KMSE-2047	0.47	1	40	3	9,100
KMSE-2048	0.48	1	40	3	9,100
KMSE-2049	0.49	1	40	3	9,100
KMSE-2050	0.5	1	40	3	7,600
KMSE-2051	0.51	1	40	3	8,300
KMSE-2052	0.52	1	40	3	8,300
KMSE-2053	0.53	1	40	3	8,300
KMSE-2054	0.54	1	40	3	8,300
KMSE-2055	0.55	1	40	3	8,300
KMSE-2056	0.56	1	40	3	8,300
KMSE-2057	0.57	1	40	3	8,300
KMSE-2058	0.58	1	40	3	8,300
KMSE-2059	0.59	1	40	3	8,300
KMSE-2060	0.6	2	40	3	7,600
KMSE-2061	0.61	2	40	3	8,300
KMSE-2062	0.62	2	40	3	8,300
KMSE-2063	0.63	2	40	3	8,300
KMSE-2064	0.64	2	40	3	8,300
KMSE-2065	0.65	2	40	3	8,300
KMSE-2066	0.66	2	40	3	8,300
KMSE-2067	0.67	2	40	3	8,300
KMSE-2068	0.68	2	40	3	8,300
KMSE-2069	0.69	2	40	3	8,300
KMSE-2070	0.7	2	40	3	7,300
KMSE-2071	0.71	2	40	3	8,000
KMSE-2072	0.72	2	40	3	8,000
KMSE-2073	0.73	2	40	3	8,000
KMSE-2074	0.74	2	40	3	8,000
KMSE-2075	0.75	2	40	3	8,000
KMSE-2076	0.76	2	40	3	8,000
KMSE-2077	0.77	2	40	3	8,000
KMSE-2078	0.78	2	40	3	8,000
KMSE-2079	0.79	2	40	3	8,000

# KMSE-2

品番 Code No.	刃径 D Flute Diameter	刃長 ℓ Flute Length	全長 L Total Length	柄径 d Shank Diameter	標準価格 Retail Price
KMSE-2080	0.8	2.5	40	3	7,300
KMSE-2081	0.81	2.5	40	3	8,000
KMSE-2082	0.82	2.5	40	3	8,000
KMSE-2083	0.83	2.5	40	3	8,000
KMSE-2084	0.84	2.5	40	3	8,000
KMSE-2085	0.85	2.5	40	3	8,000
KMSE-2086	0.86	2.5	40	3	8,000
KMSE-2087	0.87	2.5	40	3	8,000
KMSE-2088	0.88	2.5	40	3	8,000
KMSE-2089	0.89	2.5	40	3	8,000
KMSE-2090	0.9	2.5	40	3	6,700
KMSE-2091	0.91	2.5	40	3	7,600
KMSE-2092	0.92	2.5	40	3	7,600
KMSE-2093	0.93	2.5	40	3	7,600
KMSE-2094	0.94	2.5	40	3	7,600
KMSE-2095	0.95	2.5	40	3	7,600
KMSE-2096	0.96	2.5	40	3	7,600
KMSE-2097	0.97	2.5	40	3	7,600
KMSE-2098	0.98	2.5	40	3	7,600
KMSE-2099	0.99	2.5	40	3	7,600
KMSE-2100	1	3	40	3	6,400
KMSE-2101	1.01	3	40	3	7,300
KMSE-2102	1.02	3	40	3	7,300
KMSE-2103	1.03	3	40	3	7,300
KMSE-2104	1.04	3	40	3	7,300
KMSE-2105	1.05	3	40	3	7,300
KMSE-2106	1.06	3	40	3	7,300
KMSE-2107	1.07	3	40	3	7,300
KMSE-2108	1.08	3	40	3	7,300
KMSE-2109	1.09	3	40	3	7,300
KMSE-2110	1.1	3	40	3	6,400
KMSE-2111	1.11	3	40	3	7,300
KMSE-2112	1.12	3	40	3	7,300
KMSE-2113	1.13	3	40	3	7,300
KMSE-2114	1.14	3	40	3	7,300
KMSE-2115	1.15	3	40	3	7,300
KMSE-2116	1.16	3	40	3	7,300
KMSE-2117	1.17	3	40	3	7,300
KMSE-2118	1.18	3	40	3	7,300
KMSE-2119	1.19	3	40	3	7,300
KMSE-2120	1.2	3	40	3	6,400
KMSE-2121	1.21	3	40	3	7,300
KMSE-2122	1.22	3	40	3	7,300
KMSE-2123	1.23	3	40	3	7,300
KMSE-2124	1.24	3	40	3	7,300
KMSE-2125	1.25	3	40	3	7,300
KMSE-2126	1.26	3	40	3	7,300
KMSE-2127	1.27	3	40	3	7,300

品番 Code No.	刃径 D Flute Diameter	刃長 ℓ Flute Length	全長 L Total Length	柄径 d Shank Diameter	標準価格 Retail Price
KMSE-2128	1.28	3	40	3	7,300
KMSE-2129	1.29	3	40	3	7,300
KMSE-2130	1.3	3	40	3	6,400
KMSE-2131	1.31	3	40	3	7,300
KMSE-2132	1.32	3	40	3	7,300
KMSE-2133	1.33	3	40	3	7,300
KMSE-2134	1.34	3	40	3	7,300
KMSE-2135	1.35	3	40	3	7,300
KMSE-2136	1.36	3	40	3	7,300
KMSE-2137	1.37	3	40	3	7,300
KMSE-2138	1.38	3	40	3	7,300
KMSE-2139	1.39	3	40	3	7,300
KMSE-2140	1.4	3	40	3	6,400
KMSE-2141	1.41	3	40	3	7,300
KMSE-2142	1.42	3	40	3	7,300
KMSE-2143	1.43	3	40	3	7,300
KMSE-2144	1.44	3	40	3	7,300
KMSE-2145	1.45	3	40	3	7,300
KMSE-2146	1.46	3	40	3	7,300
KMSE-2147	1.47	3	40	3	7,300
KMSE-2148	1.48	3	40	3	7,300
KMSE-2149	1.49	3	40	3	7,300
KMSE-2150	1.5	5	40	3	6,400
KMSE-2151	1.51	5	40	3	7,300
KMSE-2152	1.52	5	40	3	7,300
KMSE-2153	1.53	5	40	3	7,300
KMSE-2154	1.54	5	40	3	7,300
KMSE-2155	1.55	5	40	3	7,300
KMSE-2156	1.56	5	40	3	7,300
KMSE-2157	1.57	5	40	3	7,300
KMSE-2158	1.58	5	40	3	7,300
KMSE-2159	1.59	5	40	3	7,300
KMSE-2160	1.6	5	40	3	6,400
KMSE-2161	1.61	5	40	3	7,300
KMSE-2162	1.62	5	40	3	7,300
KMSE-2163	1.63	5	40	3	7,300
KMSE-2164	1.64	5	40	3	7,300
KMSE-2165	1.65	5	40	3	7,300
KMSE-2166	1.66	5	40	3	7,300
KMSE-2167	1.67	5	40	3	7,300
KMSE-2168	1.68	5	40	3	7,300
KMSE-2169	1.69	5	40	3	7,300
KMSE-2170	1.7	5	40	3	6,400
KMSE-2171	1.71	5	40	3	7,300
KMSE-2172	1.72	5	40	3	7,300
KMSE-2173	1.73	5	40	3	7,300
KMSE-2174	1.74	5	40	3	7,300
KMSE-2175	1.75	5	40	3	7,300

# KMSE-2

品番 Code No.	刃径 D Flute Diameter	刃長 ℓ Flute Length	全長 L Total Length	柄径 d Shank Diameter	標準価格 Retail Price
KMSE-2176	1.76	5	40	3	7,300
KMSE-2177	1.77	5	40	3	7,300
KMSE-2178	1.78	5	40	3	7,300
KMSE-2179	1.79	5	40	3	7,300
KMSE-2180	1.8	5	40	3	6,400
KMSE-2181	1.81	5	40	3	7,300
KMSE-2182	1.82	5	40	3	7,300
KMSE-2183	1.83	5	40	3	7,300
KMSE-2184	1.84	5	40	3	7,300
KMSE-2185	1.85	5	40	3	7,300
KMSE-2186	1.86	5	40	3	7,300
KMSE-2187	1.87	5	40	3	7,300
KMSE-2188	1.88	5	40	3	7,300
KMSE-2189	1.89	5	40	3	7,300
KMSE-2190	1.9	5	40	3	6,200
KMSE-2191	1.91	5	40	3	7,000
KMSE-2192	1.92	5	40	3	7,000
KMSE-2193	1.93	5	40	3	7,000
KMSE-2194	1.94	5	40	3	7,000
KMSE-2195	1.95	5	40	3	7,000
KMSE-2196	1.96	5	40	3	7,000
KMSE-2197	1.97	5	40	3	7,000
KMSE-2198	1.98	5	40	3	7,000
KMSE-2199	1.99	5	40	3	7,000
KMSE-2200	2	6	40	3	6,200
KMSE-2201	2.01	6	40	3	7,000
KMSE-2202	2.02	6	40	3	7,000
KMSE-2203	2.03	6	40	3	7,000
KMSE-2204	2.04	6	40	3	7,000
KMSE-2205	2.05	6	40	3	7,000
KMSE-2206	2.06	6	40	3	7,000
KMSE-2207	2.07	6	40	3	7,000
KMSE-2208	2.08	6	40	3	7,000
KMSE-2209	2.09	6	40	3	7,000
KMSE-2210	2.1	6	40	3	6,200
KMSE-2211	2.11	6	40	3	7,000
KMSE-2212	2.12	6	40	3	7,000
KMSE-2213	2.13	6	40	3	7,000
KMSE-2214	2.14	6	40	3	7,000
KMSE-2215	2.15	6	40	3	7,000
KMSE-2216	2.16	6	40	3	7,000
KMSE-2217	2.17	6	40	3	7,000
KMSE-2218	2.18	6	40	3	7,000
KMSE-2219	2.19	6	40	3	7,000
KMSE-2220	2.2	6	40	3	6,200
KMSE-2221	2.21	6	40	3	7,000
KMSE-2222	2.22	6	40	3	7,000
KMSE-2223	2.23	6	40	3	7,000

品番 Code No.	刃径 D Flute Diameter	刃長 ℓ Flute Length	全長 L Total Length	柄径 d Shank Diameter	標準価格 Retail Price
KMSE-2224	2.24	6	40	3	7,000
KMSE-2225	2.25	6	40	3	7,000
KMSE-2226	2.26	6	40	3	7,000
KMSE-2227	2.27	6	40	3	7,000
KMSE-2228	2.28	6	40	3	7,000
KMSE-2229	2.29	6	40	3	7,000
KMSE-2230	2.3	6	40	3	6,200
KMSE-2231	2.31	6	40	3	7,000
KMSE-2232	2.32	6	40	3	7,000
KMSE-2233	2.33	6	40	3	7,000
KMSE-2234	2.34	6	40	3	7,000
KMSE-2235	2.35	6	40	3	7,000
KMSE-2236	2.36	6	40	3	7,000
KMSE-2237	2.37	6	40	3	7,000
KMSE-2238	2.38	6	40	3	7,000
KMSE-2239	2.39	6	40	3	7,000
KMSE-2240	2.4	6	40	3	6,200
KMSE-2241	2.41	6	40	3	7,000
KMSE-2242	2.42	6	40	3	7,000
KMSE-2243	2.43	6	40	3	7,000
KMSE-2244	2.44	6	40	3	7,000
KMSE-2245	2.45	6	40	3	7,000
KMSE-2246	2.46	6	40	3	7,000
KMSE-2247	2.47	6	40	3	7,000
KMSE-2248	2.48	6	40	3	7,000
KMSE-2249	2.49	6	40	3	7,000
KMSE-2250	2.5	8	40	3	6,200
KMSE-2251	2.51	8	40	3	7,000
KMSE-2252	2.52	8	40	3	7,000
KMSE-2253	2.53	8	40	3	7,000
KMSE-2254	2.54	8	40	3	7,000
KMSE-2255	2.55	8	40	3	7,000
KMSE-2256	2.56	8	40	3	7,000
KMSE-2257	2.57	8	40	3	7,000
KMSE-2258	2.58	8	40	3	7,000
KMSE-2259	2.59	8	40	3	7,000
KMSE-2260	2.6	8	40	3	6,200
KMSE-2261	2.61	8	40	3	7,000
KMSE-2262	2.62	8	40	3	7,000
KMSE-2263	2.63	8	40	3	7,000
KMSE-2264	2.64	8	40	3	7,000
KMSE-2265	2.65	8	40	3	7,000
KMSE-2266	2.66	8	40	3	7,000
KMSE-2267	2.67	8	40	3	7,000
KMSE-2268	2.68	8	40	3	7,000
KMSE-2269	2.69	8	40	3	7,000
KMSE-2270	2.7	8	40	3	6,200
KMSE-2271	2.71	8	40	3	7,000

超硬製品

Tungsten Carbide





# KMSEA-2

品番 Code No.	刃径 D Flute Diameter	刃長 ℓ Flute Length	全長 L Total Length	柄径 d Shank Diameter	標準価格 Retail Price
KMSEA-2028	0.28	0.8	50	3	12,100
KMSEA-2029	0.29	0.8	50	3	12,100
KMSEA-2030	0.3	1	50	3	11,400
KMSEA-2031	0.31	1	50	3	11,400
KMSEA-2032	0.32	1	50	3	11,400
KMSEA-2033	0.33	1	50	3	11,400
KMSEA-2034	0.34	1	50	3	11,400
KMSEA-2035	0.35	1	50	3	11,400
KMSEA-2036	0.36	1	50	3	11,400
KMSEA-2037	0.37	1	50	3	11,400
KMSEA-2038	0.38	1	50	3	11,400
KMSEA-2039	0.39	1	50	3	11,400
KMSEA-2040	0.4	1	50	3	10,000
KMSEA-2041	0.41	1	50	3	10,600
KMSEA-2042	0.42	1	50	3	10,600
KMSEA-2043	0.43	1	50	3	10,600
KMSEA-2044	0.44	1	50	3	10,600
KMSEA-2045	0.45	1	50	3	10,600
KMSEA-2046	0.46	1	50	3	10,600
KMSEA-2047	0.47	1	50	3	10,600
KMSEA-2048	0.48	1	50	3	10,600
KMSEA-2049	0.49	1	50	3	10,600
KMSEA-2050	0.5	1	50	3	8,900
KMSEA-2051	0.51	1	50	3	9,800
KMSEA-2052	0.52	1	50	3	9,800
KMSEA-2053	0.53	1	50	3	9,800
KMSEA-2054	0.54	1	50	3	9,800
KMSEA-2055	0.55	1	50	3	9,800
KMSEA-2056	0.56	1	50	3	9,800
KMSEA-2057	0.57	1	50	3	9,800
KMSEA-2058	0.58	1	50	3	9,800
KMSEA-2059	0.59	1	50	3	9,800
KMSEA-2060	0.6	2	50	3	8,900
KMSEA-2061	0.61	2	50	3	9,800
KMSEA-2062	0.62	2	50	3	9,800
KMSEA-2063	0.63	2	50	3	9,800
KMSEA-2064	0.64	2	50	3	9,800
KMSEA-2065	0.65	2	50	3	9,800
KMSEA-2066	0.66	2	50	3	9,800
KMSEA-2067	0.67	2	50	3	9,800
KMSEA-2068	0.68	2	50	3	9,800
KMSEA-2069	0.69	2	50	3	9,800
KMSEA-2070	0.7	2	50	3	8,500
KMSEA-2071	0.71	2	50	3	9,200
KMSEA-2072	0.72	2	50	3	9,200
KMSEA-2073	0.73	2	50	3	9,200
KMSEA-2074	0.74	2	50	3	9,200
KMSEA-2075	0.75	2	50	3	9,200

品番 Code No.	刃径 D Flute Diameter	刃長 ℓ Flute Length	全長 L Total Length	柄径 d Shank Diameter	標準価格 Retail Price
KMSEA-2076	0.76	2	50	3	9,200
KMSEA-2077	0.77	2	50	3	9,200
KMSEA-2078	0.78	2	50	3	9,200
KMSEA-2079	0.79	2	50	3	9,200
KMSEA-2080	0.8	2.5	50	3	8,500
KMSEA-2081	0.81	2.5	50	3	9,200
KMSEA-2082	0.82	2.5	50	3	9,200
KMSEA-2083	0.83	2.5	50	3	9,200
KMSEA-2084	0.84	2.5	50	3	9,200
KMSEA-2085	0.85	2.5	50	3	9,200
KMSEA-2086	0.86	2.5	50	3	9,200
KMSEA-2087	0.87	2.5	50	3	9,200
KMSEA-2088	0.88	2.5	50	3	9,200
KMSEA-2089	0.89	2.5	50	3	9,200
KMSEA-2090	0.9	2.5	50	3	7,800
KMSEA-2091	0.91	2.5	50	3	8,900
KMSEA-2092	0.92	2.5	50	3	8,900
KMSEA-2093	0.93	2.5	50	3	8,900
KMSEA-2094	0.94	2.5	50	3	8,900
KMSEA-2095	0.95	2.5	50	3	8,900
KMSEA-2096	0.96	2.5	50	3	8,900
KMSEA-2097	0.97	2.5	50	3	8,900
KMSEA-2098	0.98	2.5	50	3	8,900
KMSEA-2099	0.99	2.5	50	3	8,900
KMSEA-2100	1	3	50	3	7,500
KMSEA-2101	1.01	3	50	3	8,500
KMSEA-2102	1.02	3	50	3	8,500
KMSEA-2103	1.03	3	50	3	8,500
KMSEA-2104	1.04	3	50	3	8,500
KMSEA-2105	1.05	3	50	3	8,500
KMSEA-2106	1.06	3	50	3	8,500
KMSEA-2107	1.07	3	50	3	8,500
KMSEA-2108	1.08	3	50	3	8,500
KMSEA-2109	1.09	3	50	3	8,500
KMSEA-2110	1.1	3	50	3	7,500
KMSEA-2111	1.11	3	50	3	8,500
KMSEA-2112	1.12	3	50	3	8,500
KMSEA-2113	1.13	3	50	3	8,500
KMSEA-2114	1.14	3	50	3	8,500
KMSEA-2115	1.15	3	50	3	8,500
KMSEA-2116	1.16	3	50	3	8,500
KMSEA-2117	1.17	3	50	3	8,500
KMSEA-2118	1.18	3	50	3	8,500
KMSEA-2119	1.19	3	50	3	8,500
KMSEA-2120	1.2	3	50	3	7,500
KMSEA-2121	1.21	3	50	3	8,500
KMSEA-2122	1.22	3	50	3	8,500
KMSEA-2123	1.23	3	50	3	8,500

超硬製品

Tungsten Carbide

# KMSEA-2

品番 Code No.	刃径 D Flute Diameter	刃長 ℓ Flute Length	全長 L Total Length	柄径 d Shank Diameter	標準価格 Retail Price
KMSEA-2124	1.24	3	50	3	8,500
KMSEA-2125	1.25	3	50	3	8,500
KMSEA-2126	1.26	3	50	3	8,500
KMSEA-2127	1.27	3	50	3	8,500
KMSEA-2128	1.28	3	50	3	8,500
KMSEA-2129	1.29	3	50	3	8,500
KMSEA-2130	1.3	3	50	3	7,500
KMSEA-2131	1.31	3	50	3	8,500
KMSEA-2132	1.32	3	50	3	8,500
KMSEA-2133	1.33	3	50	3	8,500
KMSEA-2134	1.34	3	50	3	8,500
KMSEA-2135	1.35	3	50	3	8,500
KMSEA-2136	1.36	3	50	3	8,500
KMSEA-2137	1.37	3	50	3	8,500
KMSEA-2138	1.38	3	50	3	8,500
KMSEA-2139	1.39	3	50	3	8,500
KMSEA-2140	1.4	3	50	3	7,500
KMSEA-2141	1.41	3	50	3	8,500
KMSEA-2142	1.42	3	50	3	8,500
KMSEA-2143	1.43	3	50	3	8,500
KMSEA-2144	1.44	3	50	3	8,500
KMSEA-2145	1.45	3	50	3	8,500
KMSEA-2146	1.46	3	50	3	8,500
KMSEA-2147	1.47	3	50	3	8,500
KMSEA-2148	1.48	3	50	3	8,500
KMSEA-2149	1.49	3	50	3	8,500
KMSEA-2150	1.5	5	50	3	7,500
KMSEA-2151	1.51	5	50	3	8,500
KMSEA-2152	1.52	5	50	3	8,500
KMSEA-2153	1.53	5	50	3	8,500
KMSEA-2154	1.54	5	50	3	8,500
KMSEA-2155	1.55	5	50	3	8,500
KMSEA-2156	1.56	5	50	3	8,500
KMSEA-2157	1.57	5	50	3	8,500
KMSEA-2158	1.58	5	50	3	8,500
KMSEA-2159	1.59	5	50	3	8,500
KMSEA-2160	1.6	5	50	3	7,500
KMSEA-2161	1.61	5	50	3	8,500
KMSEA-2162	1.62	5	50	3	8,500
KMSEA-2163	1.63	5	50	3	8,500
KMSEA-2164	1.64	5	50	3	8,500
KMSEA-2165	1.65	5	50	3	8,500
KMSEA-2166	1.66	5	50	3	8,500
KMSEA-2167	1.67	5	50	3	8,500
KMSEA-2168	1.68	5	50	3	8,500
KMSEA-2169	1.69	5	50	3	8,500
KMSEA-2170	1.7	5	50	3	7,500
KMSEA-2171	1.71	5	50	3	8,500

品番 Code No.	刃径 D Flute Diameter	刃長 ℓ Flute Length	全長 L Total Length	柄径 d Shank Diameter	標準価格 Retail Price
KMSEA-2172	1.72	5	50	3	8,500
KMSEA-2173	1.73	5	50	3	8,500
KMSEA-2174	1.74	5	50	3	8,500
KMSEA-2175	1.75	5	50	3	8,500
KMSEA-2176	1.76	5	50	3	8,500
KMSEA-2177	1.77	5	50	3	8,500
KMSEA-2178	1.78	5	50	3	8,500
KMSEA-2179	1.79	5	50	3	8,500
KMSEA-2180	1.8	5	50	3	7,500
KMSEA-2181	1.81	5	50	3	8,500
KMSEA-2182	1.82	5	50	3	8,500
KMSEA-2183	1.83	5	50	3	8,500
KMSEA-2184	1.84	5	50	3	8,500
KMSEA-2185	1.85	5	50	3	8,500
KMSEA-2186	1.86	5	50	3	8,500
KMSEA-2187	1.87	5	50	3	8,500
KMSEA-2188	1.88	5	50	3	8,500
KMSEA-2189	1.89	5	50	3	8,500
KMSEA-2190	1.9	5	50	3	7,500
KMSEA-2191	1.91	5	50	3	8,500
KMSEA-2192	1.92	5	50	3	8,500
KMSEA-2193	1.93	5	50	3	8,500
KMSEA-2194	1.94	5	50	3	8,500
KMSEA-2195	1.95	5	50	3	8,500
KMSEA-2196	1.96	5	50	3	8,500
KMSEA-2197	1.97	5	50	3	8,500
KMSEA-2198	1.98	5	50	3	8,500
KMSEA-2199	1.99	5	50	3	8,500
KMSEA-2200	2	6	50	3	7,500
KMSEA-2201	2.01	6	50	3	8,500
KMSEA-2202	2.02	6	50	3	8,500
KMSEA-2203	2.03	6	50	3	8,500
KMSEA-2204	2.04	6	50	3	8,500
KMSEA-2205	2.05	6	50	3	8,500
KMSEA-2206	2.06	6	50	3	8,500
KMSEA-2207	2.07	6	50	3	8,500
KMSEA-2208	2.08	6	50	3	8,500
KMSEA-2209	2.09	6	50	3	8,500
KMSEA-2210	2.1	6	50	3	7,500
KMSEA-2211	2.11	6	50	3	8,500
KMSEA-2212	2.12	6	50	3	8,500
KMSEA-2213	2.13	6	50	3	8,500
KMSEA-2214	2.14	6	50	3	8,500
KMSEA-2215	2.15	6	50	3	8,500
KMSEA-2216	2.16	6	50	3	8,500
KMSEA-2217	2.17	6	50	3	8,500
KMSEA-2218	2.18	6	50	3	8,500
KMSEA-2219	2.19	6	50	3	8,500



# KSE-2

超硬ソリッド 2 枚刃エンドミル  
Tungsten Carbide 2 Flutes Solid Endmill

■刃径をΦ3~Φ6まで0.01とびにラインナップ  
Line-upped Φ3~Φ6 at pitch 0.01

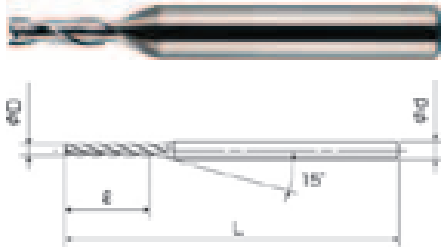

超微粒子合金 Micro Grain Tungsten Carbide



刃径の許容差 Flute Diameter Tolerance  
D 0~-0.01



柄径の許容差 Shank Diameter Tolerance  
d 0~-0.008



ネジレ角30° Twist Angle 30°



ピンカド Sharp Edge

●切削条件表はP203に記載  
●Cutting conditions are recommended on page 203. 単位[寸法: mm/価格: 円]  
Unit [size: mm/Retail Price: JPY]

品番 Code No.	刃径 D Flute Diameter	刃長 ℓ Flute Length	全長 L Total Length	柄径 d Shank Diameter	標準価格 Retail Price
KSE-2300	3	10	50	6	6,400
KSE-2301	3.01	10	50	6	7,200
KSE-2302	3.02	10	50	6	7,200
KSE-2303	3.03	10	50	6	7,200
KSE-2304	3.04	10	50	6	7,200
KSE-2305	3.05	10	50	6	7,200
KSE-2306	3.06	10	50	6	7,200
KSE-2307	3.07	10	50	6	7,200
KSE-2308	3.08	10	50	6	7,200
KSE-2309	3.09	10	50	6	7,200
KSE-2310	3.1	10	50	6	6,400
KSE-2311	3.11	10	50	6	7,200
KSE-2312	3.12	10	50	6	7,200
KSE-2313	3.13	10	50	6	7,200
KSE-2314	3.14	10	50	6	7,200
KSE-2315	3.15	10	50	6	7,200
KSE-2316	3.16	10	50	6	7,200
KSE-2317	3.17	10	50	6	7,200
KSE-2318	3.18	10	50	6	7,200
KSE-2319	3.19	10	50	6	7,200
KSE-2320	3.2	10	50	6	6,400
KSE-2321	3.21	10	50	6	7,200

品番 Code No.	刃径 D Flute Diameter	刃長 ℓ Flute Length	全長 L Total Length	柄径 d Shank Diameter	標準価格 Retail Price
KSE-2322	3.22	10	50	6	7,200
KSE-2323	3.23	10	50	6	7,200
KSE-2324	3.24	10	50	6	7,200
KSE-2325	3.25	10	50	6	7,200
KSE-2326	3.26	10	50	6	7,200
KSE-2327	3.27	10	50	6	7,200
KSE-2328	3.28	10	50	6	7,200
KSE-2329	3.29	10	50	6	7,200
KSE-2330	3.3	10	50	6	6,400
KSE-2331	3.31	10	50	6	7,200
KSE-2332	3.32	10	50	6	7,200
KSE-2333	3.33	10	50	6	7,200
KSE-2334	3.34	10	50	6	7,200
KSE-2335	3.35	10	50	6	7,200
KSE-2336	3.36	10	50	6	7,200
KSE-2337	3.37	10	50	6	7,200
KSE-2338	3.38	10	50	6	7,200
KSE-2339	3.39	10	50	6	7,200
KSE-2340	3.4	10	50	6	6,400
KSE-2341	3.41	10	50	6	7,200
KSE-2342	3.42	10	50	6	7,200
KSE-2343	3.43	10	50	6	7,200
KSE-2344	3.44	10	50	6	7,200
KSE-2345	3.45	10	50	6	7,200
KSE-2346	3.46	10	50	6	7,200
KSE-2347	3.47	10	50	6	7,200
KSE-2348	3.48	10	50	6	7,200
KSE-2349	3.49	10	50	6	7,200
KSE-2350	3.5	10	50	6	6,400
KSE-2351	3.51	10	50	6	7,200
KSE-2352	3.52	10	50	6	7,200
KSE-2353	3.53	10	50	6	7,200
KSE-2354	3.54	10	50	6	7,200
KSE-2355	3.55	10	50	6	7,200
KSE-2356	3.56	10	50	6	7,200
KSE-2357	3.57	10	50	6	7,200
KSE-2358	3.58	10	50	6	7,200
KSE-2359	3.59	10	50	6	7,200
KSE-2360	3.6	10	50	6	6,400
KSE-2361	3.61	10	50	6	7,200
KSE-2362	3.62	10	50	6	7,200
KSE-2363	3.63	10	50	6	7,200
KSE-2364	3.64	10	50	6	7,200
KSE-2365	3.65	10	50	6	7,200
KSE-2366	3.66	10	50	6	7,200
KSE-2367	3.67	10	50	6	7,200
KSE-2368	3.68	10	50	6	7,200
KSE-2369	3.69	10	50	6	7,200

超硬製品

Tungsten Carbide

# KSE-2

品番 Code No.	刃径 D Flute Diameter	刃長 ℓ Flute Length	全長 L Total Length	柄径 d Shank Diameter	標準価格 Retail Price
KSE-2370	3.7	10	50	6	6,400
KSE-2371	3.71	10	50	6	7,200
KSE-2372	3.72	10	50	6	7,200
KSE-2373	3.73	10	50	6	7,200
KSE-2374	3.74	10	50	6	7,200
KSE-2375	3.75	10	50	6	7,200
KSE-2376	3.76	10	50	6	7,200
KSE-2377	3.77	10	50	6	7,200
KSE-2378	3.78	10	50	6	7,200
KSE-2379	3.79	10	50	6	7,200
KSE-2380	3.8	10	50	6	6,400
KSE-2381	3.81	10	50	6	7,200
KSE-2382	3.82	10	50	6	7,200
KSE-2383	3.83	10	50	6	7,200
KSE-2384	3.84	10	50	6	7,200
KSE-2385	3.85	10	50	6	7,200
KSE-2386	3.86	10	50	6	7,200
KSE-2387	3.87	10	50	6	7,200
KSE-2388	3.88	10	50	6	7,200
KSE-2389	3.89	10	50	6	7,200
KSE-2390	3.9	10	50	6	6,400
KSE-2391	3.91	10	50	6	7,200
KSE-2392	3.92	10	50	6	7,200
KSE-2393	3.93	10	50	6	7,200
KSE-2394	3.94	10	50	6	7,200
KSE-2395	3.95	10	50	6	7,200
KSE-2396	3.96	10	50	6	7,200
KSE-2397	3.97	10	50	6	7,200
KSE-2398	3.98	10	50	6	7,200
KSE-2399	3.99	10	50	6	7,200
KSE-2400	4	12	50	6	6,800
KSE-2401	4.01	12	50	6	8,000
KSE-2402	4.02	12	50	6	8,000
KSE-2403	4.03	12	50	6	8,000
KSE-2404	4.04	12	50	6	8,000
KSE-2405	4.05	12	50	6	8,000
KSE-2406	4.06	12	50	6	8,000
KSE-2407	4.07	12	50	6	8,000
KSE-2408	4.08	12	50	6	8,000
KSE-2409	4.09	12	50	6	8,000
KSE-2410	4.1	12	50	6	6,800
KSE-2411	4.11	12	50	6	8,000
KSE-2412	4.12	12	50	6	8,000
KSE-2413	4.13	12	50	6	8,000
KSE-2414	4.14	12	50	6	8,000
KSE-2415	4.15	12	50	6	8,000
KSE-2416	4.16	12	50	6	8,000
KSE-2417	4.17	12	50	6	8,000

品番 Code No.	刃径 D Flute Diameter	刃長 ℓ Flute Length	全長 L Total Length	柄径 d Shank Diameter	標準価格 Retail Price
KSE-2418	4.18	12	50	6	8,000
KSE-2419	4.19	12	50	6	8,000
KSE-2420	4.2	12	50	6	6,800
KSE-2421	4.21	12	50	6	8,000
KSE-2422	4.22	12	50	6	8,000
KSE-2423	4.23	12	50	6	8,000
KSE-2424	4.24	12	50	6	8,000
KSE-2425	4.25	12	50	6	8,000
KSE-2426	4.26	12	50	6	8,000
KSE-2427	4.27	12	50	6	8,000
KSE-2428	4.28	12	50	6	8,000
KSE-2429	4.29	12	50	6	8,000
KSE-2430	4.3	12	50	6	6,800
KSE-2431	4.31	12	50	6	8,000
KSE-2432	4.32	12	50	6	8,000
KSE-2433	4.33	12	50	6	8,000
KSE-2434	4.34	12	50	6	8,000
KSE-2435	4.35	12	50	6	8,000
KSE-2436	4.36	12	50	6	8,000
KSE-2437	4.37	12	50	6	8,000
KSE-2438	4.38	12	50	6	8,000
KSE-2439	4.39	12	50	6	8,000
KSE-2440	4.4	12	50	6	6,800
KSE-2441	4.41	12	50	6	8,000
KSE-2442	4.42	12	50	6	8,000
KSE-2443	4.43	12	50	6	8,000
KSE-2444	4.44	12	50	6	8,000
KSE-2445	4.45	12	50	6	8,000
KSE-2446	4.46	12	50	6	8,000
KSE-2447	4.47	12	50	6	8,000
KSE-2448	4.48	12	50	6	8,000
KSE-2449	4.49	12	50	6	8,000
KSE-2450	4.5	12	50	6	6,800
KSE-2451	4.51	12	50	6	8,000
KSE-2452	4.52	12	50	6	8,000
KSE-2453	4.53	12	50	6	8,000
KSE-2454	4.54	12	50	6	8,000
KSE-2455	4.55	12	50	6	8,000
KSE-2456	4.56	12	50	6	8,000
KSE-2457	4.57	12	50	6	8,000
KSE-2458	4.58	12	50	6	8,000
KSE-2459	4.59	12	50	6	8,000
KSE-2460	4.6	12	50	6	6,800
KSE-2461	4.61	12	50	6	8,000
KSE-2462	4.62	12	50	6	8,000
KSE-2463	4.63	12	50	6	8,000
KSE-2464	4.64	12	50	6	8,000
KSE-2465	4.65	12	50	6	8,000

超硬製品

Tungsten Carbide

# KSE-2

品番 Code No.	刃径 D Flute Diameter	刃長 ℓ Flute Length	全長 L Total Length	柄径 d Shank Diameter	標準価格 Retail Price
KSE-2466	4.66	12	50	6	8,000
KSE-2467	4.67	12	50	6	8,000
KSE-2468	4.68	12	50	6	8,000
KSE-2469	4.69	12	50	6	8,000
KSE-2470	4.7	12	50	6	6,800
KSE-2471	4.71	12	50	6	8,000
KSE-2472	4.72	12	50	6	8,000
KSE-2473	4.73	12	50	6	8,000
KSE-2474	4.74	12	50	6	8,000
KSE-2475	4.75	12	50	6	8,000
KSE-2476	4.76	12	50	6	8,000
KSE-2477	4.77	12	50	6	8,000
KSE-2478	4.78	12	50	6	8,000
KSE-2479	4.79	12	50	6	8,000
KSE-2480	4.8	12	50	6	6,800
KSE-2481	4.81	12	50	6	8,000
KSE-2482	4.82	12	50	6	8,000
KSE-2483	4.83	12	50	6	8,000
KSE-2484	4.84	12	50	6	8,000
KSE-2485	4.85	12	50	6	8,000
KSE-2486	4.86	12	50	6	8,000
KSE-2487	4.87	12	50	6	8,000
KSE-2488	4.88	12	50	6	8,000
KSE-2489	4.89	12	50	6	8,000
KSE-2490	4.9	12	50	6	6,800
KSE-2491	4.91	12	50	6	8,000
KSE-2492	4.92	12	50	6	8,000
KSE-2493	4.93	12	50	6	8,000
KSE-2494	4.94	12	50	6	8,000
KSE-2495	4.95	12	50	6	8,000
KSE-2496	4.96	12	50	6	8,000
KSE-2497	4.97	12	50	6	8,000
KSE-2498	4.98	12	50	6	8,000
KSE-2499	4.99	12	50	6	8,000
KSE-2500	5	15	50	6	7,200
KSE-2501	5.01	15	50	6	8,500
KSE-2502	5.02	15	50	6	8,500
KSE-2503	5.03	15	50	6	8,500
KSE-2504	5.04	15	50	6	8,500
KSE-2505	5.05	15	50	6	8,500
KSE-2506	5.06	15	50	6	8,500
KSE-2507	5.07	15	50	6	8,500
KSE-2508	5.08	15	50	6	8,500
KSE-2509	5.09	15	50	6	8,500
KSE-2510	5.1	15	50	6	7,200
KSE-2511	5.11	15	50	6	8,500
KSE-2512	5.12	15	50	6	8,500
KSE-2513	5.13	15	50	6	8,500

品番 Code No.	刃径 D Flute Diameter	刃長 ℓ Flute Length	全長 L Total Length	柄径 d Shank Diameter	標準価格 Retail Price
KSE-2514	5.14	15	50	6	8,500
KSE-2515	5.15	15	50	6	8,500
KSE-2516	5.16	15	50	6	8,500
KSE-2517	5.17	15	50	6	8,500
KSE-2518	5.18	15	50	6	8,500
KSE-2519	5.19	15	50	6	8,500
KSE-2520	5.2	15	50	6	7,200
KSE-2521	5.21	15	50	6	8,500
KSE-2522	5.22	15	50	6	8,500
KSE-2523	5.23	15	50	6	8,500
KSE-2524	5.24	15	50	6	8,500
KSE-2525	5.25	15	50	6	8,500
KSE-2526	5.26	15	50	6	8,500
KSE-2527	5.27	15	50	6	8,500
KSE-2528	5.28	15	50	6	8,500
KSE-2529	5.29	15	50	6	8,500
KSE-2530	5.3	15	50	6	7,200
KSE-2531	5.31	15	50	6	8,500
KSE-2532	5.32	15	50	6	8,500
KSE-2533	5.33	15	50	6	8,500
KSE-2534	5.34	15	50	6	8,500
KSE-2535	5.35	15	50	6	8,500
KSE-2536	5.36	15	50	6	8,500
KSE-2537	5.37	15	50	6	8,500
KSE-2538	5.38	15	50	6	8,500
KSE-2539	5.39	15	50	6	8,500
KSE-2540	5.4	15	50	6	7,200
KSE-2541	5.41	15	50	6	8,500
KSE-2542	5.42	15	50	6	8,500
KSE-2543	5.43	15	50	6	8,500
KSE-2544	5.44	15	50	6	8,500
KSE-2545	5.45	15	50	6	8,500
KSE-2546	5.46	15	50	6	8,500
KSE-2547	5.47	15	50	6	8,500
KSE-2548	5.48	15	50	6	8,500
KSE-2549	5.49	15	50	6	8,500
KSE-2550	5.5	15	50	6	7,200
KSE-2551	5.51	15	50	6	8,500
KSE-2552	5.52	15	50	6	8,500
KSE-2553	5.53	15	50	6	8,500
KSE-2554	5.54	15	50	6	8,500
KSE-2555	5.55	15	50	6	8,500
KSE-2556	5.56	15	50	6	8,500
KSE-2557	5.57	15	50	6	8,500
KSE-2558	5.58	15	50	6	8,500
KSE-2559	5.59	15	50	6	8,500
KSE-2560	5.6	15	50	6	7,200
KSE-2561	5.61	15	50	6	8,500





# KSEL-2

## 超硬ロングエンドミル Tungsten Carbide Long Endmill

■刃長が刃径の4倍～最大12倍までラインナップ  
Line-upped flute length 4 times to max 12 times of flute diameter

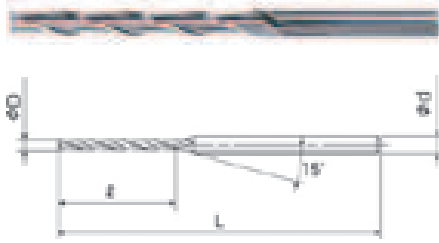

超微粒子合金 Micro Grain Tungsten Carbide



刃径の許容差 Flute Diameter Tolerance  
D 0～-0.01



柄径の許容差 Shank Diameter Tolerance  
d=3 0～-0.006  
3 < d ≤ 6 0～-0.008



ネジレ角30° Twist Angle 30°

●切削条件表はP204に記載  
●Cutting conditions are recommended on page 204. Unit [寸法: mm / 価格: 円]  
Unit [size: mm / Retail Price: JPY]

品番 Code No.	刃径 D Flute Diameter	刃長 ℓ Flute Length	全長 L Total Length	柄径 d Shank Diameter	標準価格 Retail Price
KSEL-201003	0.1	0.3	40	3	16,000
KSEL-201004	0.1	0.4	40	3	16,500
KSEL-201005	0.1	0.5	40	3	17,000
KSEL-201006	0.1	0.6	40	3	17,400
KSEL-201007	0.1	0.7	40	3	17,600
KSEL-201008	0.1	0.8	40	3	18,500
KSEL-201010	0.1	1	40	3	19,100
KSEL-201012	0.1	1.2	40	3	19,500
KSEL-201015	0.1	1.5	40	3	20,000
KSEL-201505	0.15	0.5	40	3	14,100
KSEL-201510	0.15	1	40	3	15,900
KSEL-201515	0.15	1.5	40	3	17,600
KSEL-201520	0.15	2	40	3	18,400
KSEL-202006	0.2	0.6	40	3	10,600
KSEL-202010	0.2	1	40	3	11,300
KSEL-202015	0.2	1.5	40	3	12,300
KSEL-202020	0.2	2	40	3	13,400
KSEL-202025	0.2	2.5	40	3	14,000
KSEL-202510	0.25	1	40	3	11,300
KSEL-202520	0.25	2	40	3	12,300
KSEL-202525	0.25	2.5	40	3	13,400
KSEL-202530	0.25	3	40	3	14,000
KSEL-203015	0.3	1.5	40	3	10,200
KSEL-203020	0.3	2	40	3	11,300

品番 Code No.	刃径 D Flute Diameter	刃長 ℓ Flute Length	全長 L Total Length	柄径 d Shank Diameter	標準価格 Retail Price
KSEL-203030	0.3	3	40	3	12,300
KSEL-203040	0.3	4	40	3	13,400
KSEL-203520	0.35	2	40	3	10,200
KSEL-203530	0.35	3	40	3	11,300
KSEL-203540	0.35	4	40	3	12,300
KSEL-203550	0.35	5	40	3	13,400
KSEL-204020	0.4	2	40	3	9,600
KSEL-204030	0.4	3	40	3	10,600
KSEL-204040	0.4	4	40	3	11,700
KSEL-204050	0.4	5	40	3	12,400
KSEL-204520	0.45	2	40	3	9,400
KSEL-204530	0.45	3	40	3	9,600
KSEL-204540	0.45	4	40	3	10,600
KSEL-204550	0.45	5	40	3	11,700
KSEL-204560	0.45	6	40	3	12,400
KSEL-205015	0.5	1.5	40	3	8,400
KSEL-205020	0.5	2	40	3	8,500
KSEL-205025	0.5	2.5	40	3	8,500
KSEL-205030	0.5	3	40	3	9,600
KSEL-205035	0.5	3.5	40	3	9,600
KSEL-205040	0.5	4	40	3	9,900
KSEL-205050	0.5	5	40	3	10,600
KSEL-205060	0.5	6	40	3	11,700
KSEL-205520	0.55	2	40	3	8,700
KSEL-205530	0.55	3	40	3	9,600
KSEL-205540	0.55	4	40	3	9,900
KSEL-205550	0.55	5	40	3	10,600
KSEL-205560	0.55	6	40	3	11,700
KSEL-206030	0.6	3	40	3	8,500
KSEL-206040	0.6	4	40	3	9,400
KSEL-206050	0.6	5	40	3	10,200
KSEL-206060	0.6	6	40	3	10,700
KSEL-206530	0.65	3	40	3	8,500
KSEL-206545	0.65	4.5	40	3	9,400
KSEL-206560	0.65	6	40	3	10,200
KSEL-206570	0.65	7	40	3	10,700
KSEL-207030	0.7	3	40	3	7,500
KSEL-207040	0.7	4	40	3	8,500
KSEL-207050	0.7	5	40	3	9,400
KSEL-207060	0.7	6	40	3	10,200
KSEL-207070	0.7	7	40	3	11,000
KSEL-207080	0.7	8	40	3	11,700
KSEL-207540	0.75	4	40	3	8,500
KSEL-207560	0.75	6	40	3	9,900
KSEL-207580	0.75	8	40	3	11,300
KSEL-207590	0.75	9	40	3	12,700
KSEL-208030	0.8	3	40	3	7,000
KSEL-208035	0.8	3.5	40	3	7,000

# KSEL-2

品番 Code No.	刃径 D Flute Diameter	刃長 ℓ Flute Length	全長 L Total Length	柄径 d Shank Diameter	標準価格 Retail Price
KSEL-208040	0.8	4	40	3	8,500
KSEL-208060	0.8	6	40	3	8,500
KSEL-208080	0.8	8	40	3	9,900
KSEL-208100	0.8	10	40	3	11,300
KSEL-208120	0.8	12	40	3	13,000
KSEL-208550	0.85	5	40	3	8,500
KSEL-208560	0.85	6	40	3	8,800
KSEL-208580	0.85	8	40	3	9,900
KSEL-208510	0.85	10	40	3	11,400
KSEL-209050	0.9	5	40	3	7,500
KSEL-209060	0.9	6	40	3	8,500
KSEL-209080	0.9	8	40	3	9,900
KSEL-209100	0.9	10	40	3	11,400
KSEL-209560	0.95	6	40	3	8,500
KSEL-209580	0.95	8	40	3	9,900
KSEL-209510	0.95	10	40	3	10,600
KSEL-209512	0.95	12	40	3	11,700
KSEL-210040	1	4	45	4	7,000
KSEL-210050	1	5	45	4	7,800
KSEL-210060	1	6	45	4	8,500
KSEL-210070	1	7	45	4	8,500
KSEL-210080	1	8	45	4	8,500
KSEL-210090	1	9	45	4	8,800
KSEL-210100	1	10	45	4	9,200
KSEL-210120	1	12	45	4	10,600
KSEL-210140	1	14	45	4	12,000
KSEL-210560	1.05	6	45	4	8,500
KSEL-210580	1.05	8	45	4	8,500
KSEL-210510	1.05	10	45	4	9,200
KSEL-210512	1.05	12	45	4	10,700
KSEL-211060	1.1	6	45	4	7,800
KSEL-211080	1.1	8	45	4	8,500
KSEL-211100	1.1	10	45	4	9,200
KSEL-211120	1.1	12	45	4	10,700
KSEL-211580	1.15	8	45	4	8,500
KSEL-211510	1.15	10	45	4	8,500
KSEL-211512	1.15	12	45	4	9,200
KSEL-211514	1.15	14	45	4	11,000
KSEL-212060	1.2	6	45	4	7,800
KSEL-212080	1.2	8	45	4	8,500
KSEL-212100	1.2	10	45	4	8,500
KSEL-212120	1.2	12	45	4	9,200
KSEL-212140	1.2	14	45	4	11,000
KSEL-212580	1.25	8	45	4	8,500
KSEL-212510	1.25	10	45	4	8,500
KSEL-212512	1.25	12	45	4	9,200
KSEL-212514	1.25	14	45	4	11,000
KSEL-213060	1.3	6	45	4	7,800

品番 Code No.	刃径 D Flute Diameter	刃長 ℓ Flute Length	全長 L Total Length	柄径 d Shank Diameter	標準価格 Retail Price
KSEL-213080	1.3	8	45	4	8,500
KSEL-213100	1.3	10	45	4	8,500
KSEL-213120	1.3	12	45	4	9,200
KSEL-213150	1.3	15	45	4	11,700
KSEL-213580	1.35	8	45	4	8,500
KSEL-213510	1.35	10	45	4	8,500
KSEL-213512	1.35	12	45	4	9,200
KSEL-213515	1.35	15	45	4	11,700
KSEL-214060	1.4	6	45	4	7,800
KSEL-214080	1.4	8	45	4	8,800
KSEL-214100	1.4	10	45	4	8,800
KSEL-214120	1.4	12	45	4	9,600
KSEL-214140	1.4	14	45	4	11,000
KSEL-214160	1.4	16	45	4	12,000
KSEL-214580	1.45	8	45	4	8,800
KSEL-214512	1.45	12	45	4	9,600
KSEL-214515	1.45	15	50	4	10,600
KSEL-214518	1.45	18	50	4	12,000
KSEL-215060	1.5	6	45	4	7,800
KSEL-215080	1.5	8	45	4	8,500
KSEL-215100	1.5	10	45	4	9,200
KSEL-215120	1.5	12	45	4	9,200
KSEL-215150	1.5	15	50	4	10,600
KSEL-215180	1.5	18	55	4	11,300
KSEL-215200	1.5	20	60	4	12,300
KSEL-215580	1.55	8	45	4	8,800
KSEL-215512	1.55	12	45	4	9,600
KSEL-215516	1.55	16	50	4	10,600
KSEL-215520	1.55	20	60	4	12,500
KSEL-216080	1.6	8	45	4	7,800
KSEL-216100	1.6	10	45	4	9,200
KSEL-216120	1.6	12	45	4	9,200
KSEL-216160	1.6	16	50	4	10,600
KSEL-216200	1.6	20	60	4	12,500
KSEL-216580	1.65	8	45	4	7,800
KSEL-216512	1.65	12	45	4	9,200
KSEL-216516	1.65	16	50	4	10,600
KSEL-216520	1.65	20	60	4	12,500
KSEL-217080	1.7	8	45	4	7,800
KSEL-217100	1.7	10	45	4	9,200
KSEL-217120	1.7	12	45	4	9,200
KSEL-217150	1.7	15	50	4	9,900
KSEL-217170	1.7	17	50	4	10,600
KSEL-217210	1.7	21	60	4	12,500
KSEL-217510	1.75	10	45	4	9,200
KSEL-217515	1.75	15	50	4	9,200
KSEL-217518	1.75	18	55	4	10,600
KSEL-217521	1.75	21	60	4	12,500

超硬製品

Tungsten Carbide

# KSEL-2

品番 Code No.	刃径 D Flute Diameter	刃長 ℓ Flute Length	全長 L Total Length	柄径 d Shank Diameter	標準価格 Retail Price
KSEL-218080	1.8	8	45	4	7,800
KSEL-218100	1.8	10	45	4	9,200
KSEL-218120	1.8	12	45	4	9,200
KSEL-218150	1.8	15	50	4	9,900
KSEL-218180	1.8	18	55	4	10,600
KSEL-218220	1.8	22	60	4	12,500
KSEL-218510	1.85	10	45	4	9,200
KSEL-218515	1.85	15	50	4	9,900
KSEL-218518	1.85	18	55	4	10,600
KSEL-218522	1.85	22	60	4	12,500
KSEL-219080	1.9	8	45	4	7,800
KSEL-219100	1.9	10	45	4	9,200
KSEL-219120	1.9	12	45	4	9,200
KSEL-219150	1.9	15	50	4	9,900
KSEL-219190	1.9	19	55	4	10,600
KSEL-219220	1.9	22	60	4	12,500
KSEL-219510	1.95	10	45	4	9,200
KSEL-219515	1.95	15	50	4	9,900
KSEL-219520	1.95	20	60	4	10,600
KSEL-219524	1.95	24	60	4	12,500
KSEL-220080	2	8	45	4	7,000
KSEL-220100	2	10	45	4	7,800
KSEL-220120	2	12	45	4	7,800
KSEL-220150	2	15	50	4	8,800
KSEL-220170	2	17	55	4	9,200
KSEL-220200	2	20	60	4	10,200
KSEL-220220	2	22	60	4	11,000
KSEL-220240	2	24	60	4	12,000
KSEL-221100	2.1	10	45	4	7,800
KSEL-221150	2.1	15	50	4	8,800
KSEL-221200	2.1	20	60	4	10,200
KSEL-221250	2.1	25	60	4	12,000
KSEL-222100	2.2	10	45	4	7,800
KSEL-222150	2.2	15	50	4	8,800
KSEL-222200	2.2	20	60	4	10,200
KSEL-222250	2.2	25	60	4	1,2000
KSEL-223100	2.3	10	45	4	7,800
KSEL-223150	2.3	15	50	4	8,800
KSEL-223200	2.3	20	60	4	10,200
KSEL-223250	2.3	25	60	4	12,000
KSEL-224100	2.4	10	45	4	7,800
KSEL-224150	2.4	15	50	4	8,800
KSEL-224200	2.4	20	60	4	10,200
KSEL-224250	2.4	25	60	4	12,000
KSEL-225100	2.5	10	45	4	7,000
KSEL-225150	2.5	15	50	4	7,800
KSEL-225200	2.5	20	60	4	8,800
KSEL-225250	2.5	25	60	4	10,200

品番 Code No.	刃径 D Flute Diameter	刃長 ℓ Flute Length	全長 L Total Length	柄径 d Shank Diameter	標準価格 Retail Price
KSEL-225300	2.5	30	70	4	12,000
KSEL-226100	2.6	10	45	4	7,000
KSEL-226150	2.6	15	50	4	7,800
KSEL-226200	2.6	20	60	4	8,800
KSEL-226250	2.6	25	60	4	10,200
KSEL-226300	2.6	30	70	4	12,000
KSEL-227100	2.7	10	45	4	7,000
KSEL-227150	2.7	15	50	4	7,800
KSEL-227200	2.7	20	60	4	8,800
KSEL-227250	2.7	25	60	4	10,200
KSEL-227300	2.7	30	70	4	12,000
KSEL-228100	2.8	10	45	4	7,000
KSEL-228150	2.8	15	50	4	7,800
KSEL-228200	2.8	20	60	4	8,800
KSEL-228250	2.8	25	60	4	10,200
KSEL-228300	2.8	30	70	4	12,000
KSEL-229150	2.9	15	50	4	7,800
KSEL-229200	2.9	20	60	4	8,800
KSEL-229250	2.9	25	60	4	10,200
KSEL-229300	2.9	30	70	4	12,000
KSEL-230150	3	15	60	6	7,800
KSEL-230200	3	20	60	6	8,500
KSEL-230250	3	25	70	6	8,800
KSEL-230300	3	30	70	6	10,200
KSEL-231300	3.1	30	70	6	11,300
KSEL-232300	3.2	30	70	6	11,300
KSEL-233300	3.3	30	70	6	11,300
KSEL-234300	3.4	30	70	6	11,300
KSEL-235200	3.5	20	70	6	8,500
KSEL-235250	3.5	25	70	6	8,800
KSEL-235300	3.5	30	70	6	10,200
KSEL-236300	3.6	30	70	6	11,300
KSEL-237300	3.7	30	70	6	11,300
KSEL-238300	3.8	30	70	6	11,300
KSEL-239300	3.9	30	70	6	11,300
KSEL-240200	4	20	70	6	9,200
KSEL-240250	4	25	70	6	10,200
KSEL-240300	4	30	70	6	11,300
KSEL-240350	4	35	80	6	12,000
KSEL-240400	4	40	80	6	12,800
KSEL-241300	4.1	30	70	6	12,300
KSEL-242300	4.2	30	70	6	12,300
KSEL-243300	4.3	30	70	6	12,300
KSEL-244300	4.4	30	70	6	12,300
KSEL-245300	4.5	30	70	6	11,300
KSEL-245350	4.5	35	80	6	12,000
KSEL-245400	4.5	40	80	6	12,800
KSEL-246300	4.6	30	70	6	12,300







# KMSEA-4

超硬ミニチュア 4 枚刃エンドミル  
Tungsten Carbide Miniature 4 Flutes Solid Endmill  
TiAlN Coating

■刃径をΦ0.5~Φ3まで0.1とびにラインナップ  
Line-upped Φ0.5~Φ3 at pitch 0.1



超微粒子合金 Micro Grain Tungsten Carbide



刃径の許容差 Flute Diameter Tolerance  
D 0~-0.01



柄径の許容差 Shank Diameter Tolerance  
d 0~-0.006



ネジレ角30° Twist Angle 30°



ピンカド Sharp Edge



TiAlNコート TiAlN Coating

●切削条件表はP208に記載  
●Cutting conditions are recommended on page 208.

単位[寸法:mm/価格:円]  
Unit [size:mm/Retail Price:JPY]

品番 Code No.	刃径 D Flute Diameter	刃長 ℓ Flute Length	全長 L Total Length	柄径 d Shank Diameter	標準価格 Retail Price
KMSEA-4050	0.5	1	60	3	12,800
KMSEA-4060	0.6	2	60	3	11,700
KMSEA-4070	0.7	2	60	3	11,300
KMSEA-4080	0.8	2.5	60	3	10,600
KMSEA-4090	0.9	2.5	60	3	10,600
KMSEA-4100	1	3	60	3	10,100
KMSEA-4110	1.1	3	60	3	10,100
KMSEA-4120	1.2	3	60	3	9,900
KMSEA-4130	1.3	3	60	3	9,900
KMSEA-4140	1.4	3	60	3	9,900
KMSEA-4150	1.5	3	60	3	9,700
KMSEA-4160	1.6	3	60	3	9,700
KMSEA-4170	1.7	3	60	3	9,700
KMSEA-4180	1.8	3	60	3	9,700
KMSEA-4190	1.9	3	60	3	9,700
KMSEA-4200	2	6	60	3	9,400
KMSEA-4210	2.1	6	60	3	9,400
KMSEA-4220	2.2	6	60	3	9,400
KMSEA-4230	2.3	6	60	3	9,400
KMSEA-4240	2.4	6	60	3	9,400
KMSEA-4250	2.5	8	60	3	9,400
KMSEA-4260	2.6	8	60	3	9,400
KMSEA-4270	2.7	8	60	3	9,400
KMSEA-4280	2.8	8	60	3	9,400
KMSEA-4290	2.9	8	60	3	9,400
KMSEA-4300	3	8	60	3	9,600

品番 Code No.	刃径 D Flute Diameter	刃長 ℓ Flute Length	全長 L Total Length	柄径 d Shank Diameter	標準価格 Retail Price

超硬製品

Tungsten Carbide

# KRE-2

## 超硬リブ用エンドミル Tungsten Carbide Long Neck Endmill

- 刃径Φ0.2~Φ6まで0.1とびにラインナップ  
Line-upped Φ0.2~Φ6 at pitch 0.1
- 深い加工用に首下を長くとりました  
Long neck type for deep processing

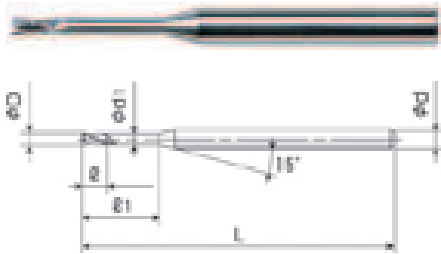

**MG** 超微粒子合金 Micro Grain Tungsten Carbide

刃径の許容差 Flute Diameter Tolerance  
D 0~-0.01

柄径の許容差 Shank Diameter Tolerance  
d 0~-0.008

ネジレ角30° Twist Angle 30°

ピンカド Sharp Edge

● 切削条件表はP209に記載 単位 [寸法 : mm / 価格 : 円]  
● Cutting conditions are recommended on page 209. Unit [size : mm / Retail Price : JPY]

品番 Code No.	刃径 D Flute Diameter	有効長 L1 Effective Length	刃長 L Flute Length	首下径 d1 Neck Diameter	全長 L Total Length	柄径 d Shank Diameter	標準価格 Retail Price
KRE-202005	0.2	0.5	0.3	0.18	40	4	10,600
KRE-202010	0.2	1	0.3	0.18	40	4	12,000
KRE-202015	0.2	1.5	0.3	0.18	40	4	13,800
KRE-202020	0.2	2	0.3	0.18	40	4	14,100
KRE-202030	0.2	3	0.3	0.18	40	4	14,500
KRE-202040	0.2	4	0.3	0.18	40	4	15,200
KRE-202050	0.2	5	0.3	0.18	40	4	15,900
KRE-203010	0.3	1	0.4	0.28	40	4	10,600
KRE-203020	0.3	2	0.4	0.28	40	4	12,000
KRE-203030	0.3	3	0.4	0.28	40	4	12,000
KRE-203040	0.3	4	0.4	0.28	40	4	12,000
KRE-203060	0.3	6	0.4	0.28	50	4	13,400
KRE-203080	0.3	8	0.4	0.28	50	4	14,900
KRE-203100	0.3	10	0.4	0.28	50	4	15,900
KRE-204020	0.4	2	0.6	0.37	40	4	10,600
KRE-204030	0.4	3	0.6	0.37	40	4	12,000
KRE-204040	0.4	4	0.6	0.37	40	4	12,000
KRE-204060	0.4	6	0.6	0.37	50	4	13,400
KRE-204080	0.4	8	0.6	0.37	50	4	14,900
KRE-204100	0.4	10	0.6	0.37	50	4	15,900

品番 Code No.	刃径 D Flute Diameter	有効長 L1 Effective Length	刃長 L Flute Length	首下径 d1 Neck Diameter	全長 L Total Length	柄径 d Shank Diameter	標準価格 Retail Price
KRE-205020	0.5	2	0.7	0.46	40	4	5,300
KRE-205040	0.5	4	0.7	0.46	40	4	5,300
KRE-205060	0.5	6	0.7	0.46	50	4	5,300
KRE-205080	0.5	8	0.7	0.46	50	4	7,000
KRE-205100	0.5	10	0.7	0.46	50	4	8,800
KRE-205120	0.5	12	0.7	0.46	50	4	8,800
KRE-205160	0.5	16	0.7	0.46	60	4	10,600
KRE-205200	0.5	20	0.7	0.46	60	4	12,300
KRE-206020	0.6	2	0.9	0.56	40	4	5,300
KRE-206040	0.6	4	0.9	0.56	40	4	5,300
KRE-206060	0.6	6	0.9	0.56	50	4	5,300
KRE-206080	0.6	8	0.9	0.56	50	4	7,000
KRE-206100	0.6	10	0.9	0.56	50	4	8,800
KRE-206120	0.6	12	0.9	0.56	50	4	8,800
KRE-206160	0.6	16	0.9	0.56	60	4	10,600
KRE-206200	0.6	20	0.9	0.56	60	4	12,300
KRE-207020	0.7	2	1	0.66	40	4	5,300
KRE-207040	0.7	4	1	0.66	40	4	5,300
KRE-207060	0.7	6	1	0.66	50	4	5,300
KRE-207080	0.7	8	1	0.66	50	4	7,000
KRE-207100	0.7	10	1	0.66	50	4	8,800
KRE-207120	0.7	12	1	0.66	50	4	8,800
KRE-207160	0.7	16	1	0.66	60	4	10,600
KRE-207200	0.7	20	1	0.66	60	4	12,300
KRE-208040	0.8	4	1.2	0.76	40	4	5,300
KRE-208060	0.8	6	1.2	0.76	50	4	5,300
KRE-208080	0.8	8	1.2	0.76	50	4	5,300
KRE-208100	0.8	10	1.2	0.76	50	4	7,000
KRE-208120	0.8	12	1.2	0.76	50	4	8,500
KRE-208160	0.8	16	1.2	0.76	60	4	9,900
KRE-208200	0.8	20	1.2	0.76	60	4	11,300
KRE-209060	0.9	6	1.4	0.86	50	4	5,300
KRE-209080	0.9	8	1.4	0.86	50	4	5,300
KRE-209100	0.9	10	1.4	0.86	50	4	5,300
KRE-209120	0.9	12	1.4	0.86	50	4	7,000
KRE-209160	0.9	16	1.4	0.86	60	4	9,900
KRE-209200	0.9	20	1.4	0.86	60	4	11,300
KRE-210060	1	6	1.5	0.95	50	4	5,300
KRE-210080	1	8	1.5	0.95	50	4	5,300
KRE-210100	1	10	1.5	0.95	50	4	5,300
KRE-210120	1	12	1.5	0.95	50	4	5,300
KRE-210160	1	16	1.5	0.95	60	4	7,800
KRE-210200	1	20	1.5	0.95	60	4	8,800
KRE-210250	1	25	1.5	0.95	70	4	9,900
KRE-210300	1	30	1.5	0.95	70	4	11,300
KRE-211060	1.1	6	1.6	1.05	50	4	5,700
KRE-211120	1.1	12	1.6	1.05	50	4	5,700
KRE-211160	1.1	16	1.6	1.05	60	4	6,800



# KRE-2

品番 Code No.	刃径 D Flute Diameter	有効長 ℓ1 Effective Length	刃長 ℓ Flute Length	首下径 d1 Neck Diameter	全長 L Total Length	柄径 d Shank Diameter	標準価格 Retail Price
KRE-211200	1.1	20	1.6	1.05	60	4	6,800
KRE-211300	1.1	30	1.6	1.05	70	4	10,000
KRE-212060	1.2	6	1.8	1.15	50	4	6,400
KRE-212120	1.2	12	1.8	1.15	50	4	6,400
KRE-212160	1.2	16	1.8	1.15	60	4	6,400
KRE-212200	1.2	20	1.8	1.15	60	4	7,800
KRE-212300	1.2	30	1.8	1.15	70	4	10,000
KRE-213060	1.3	6	1.9	1.25	50	4	6,600
KRE-213120	1.3	12	1.9	1.25	50	4	6,600
KRE-213160	1.3	16	1.9	1.25	60	4	6,800
KRE-213200	1.3	20	1.9	1.25	60	4	6,800
KRE-213300	1.3	30	1.9	1.25	70	4	10,000
KRE-214060	1.4	6	2.1	1.35	50	4	6,500
KRE-214120	1.4	12	2.1	1.35	50	4	6,500
KRE-214160	1.4	16	2.1	1.35	60	4	6,500
KRE-214200	1.4	20	2.1	1.35	60	4	6,800
KRE-214300	1.4	30	2.1	1.35	70	4	10,000
KRE-215100	1.5	10	2.3	1.45	50	4	5,300
KRE-215120	1.5	12	2.3	1.45	50	4	5,300
KRE-215160	1.5	16	2.3	1.45	60	4	5,300
KRE-215200	1.5	20	2.3	1.45	60	4	5,300
KRE-215250	1.5	25	2.3	1.45	70	4	9,200
KRE-215300	1.5	30	2.3	1.45	70	4	11,300
KRE-216100	1.6	10	2.4	1.55	50	4	6,900
KRE-216160	1.6	16	2.4	1.55	60	4	6,900
KRE-216200	1.6	20	2.4	1.55	60	4	7,000
KRE-216300	1.6	30	2.4	1.55	70	4	10,000
KRE-217100	1.7	10	2.5	1.65	50	4	7,200
KRE-217160	1.7	16	2.5	1.65	60	4	7,200
KRE-217200	1.7	20	2.5	1.65	60	4	7,400
KRE-217300	1.7	30	2.5	1.65	70	4	10,200
KRE-218100	1.8	10	2.7	1.75	50	4	6,900
KRE-218160	1.8	16	2.7	1.75	60	4	6,900
KRE-218200	1.8	20	2.7	1.75	60	4	7,000
KRE-218300	1.8	30	2.7	1.75	70	4	10,000
KRE-219100	1.9	10	2.8	1.85	50	4	7,500
KRE-219160	1.9	16	2.8	1.85	60	4	7,500
KRE-219200	1.9	20	2.8	1.85	60	4	8,500
KRE-219300	1.9	30	2.8	1.85	70	4	10,000
KRE-220100	2	10	3	1.94	50	4	5,300
KRE-220120	2	12	3	1.94	50	4	5,300
KRE-220140	2	14	3	1.94	50	4	5,300
KRE-220160	2	16	3	1.94	60	4	5,300
KRE-220180	2	18	3	1.94	60	4	5,300
KRE-220200	2	20	3	1.94	60	4	5,300
KRE-220250	2	25	3	1.94	70	4	5,700
KRE-220300	2	30	3	1.94	70	4	7,000
KRE-220350	2	35	3	1.94	80	4	11,300

品番 Code No.	刃径 D Flute Diameter	有効長 ℓ1 Effective Length	刃長 ℓ Flute Length	首下径 d1 Neck Diameter	全長 L Total Length	柄径 d Shank Diameter	標準価格 Retail Price
KRE-220400	2	40	3	1.94	80	4	12,800
KRE-221120	2.1	12	3.1	2.04	50	4	7,500
KRE-221160	2.1	16	3.1	2.04	60	4	7,500
KRE-221200	2.1	20	3.1	2.04	60	4	8,500
KRE-221300	2.1	30	3.1	2.04	70	4	10,000
KRE-222120	2.2	12	3.3	2.14	50	4	7,500
KRE-222160	2.2	16	3.3	2.14	60	4	7,500
KRE-222200	2.2	20	3.3	2.14	60	4	8,500
KRE-222300	2.2	30	3.3	2.14	70	4	10,000
KRE-223120	2.3	12	3.4	2.24	50	4	7,500
KRE-223160	2.3	16	3.4	2.24	60	4	7,500
KRE-223200	2.3	20	3.4	2.24	60	4	8,500
KRE-223300	2.3	30	3.4	2.24	70	4	10,000
KRE-224120	2.4	12	3.6	2.34	50	4	7,500
KRE-224160	2.4	16	3.6	2.34	60	4	7,500
KRE-224200	2.4	20	3.6	2.34	60	4	8,500
KRE-224300	2.4	30	3.6	2.34	70	4	10,000
KRE-225120	2.5	12	3.7	2.4	50	4	6,900
KRE-225160	2.5	16	3.7	2.4	60	4	6,900
KRE-225200	2.5	20	3.7	2.4	60	4	6,900
KRE-225300	2.5	30	3.7	2.4	70	4	7,700
KRE-225400	2.5	40	3.7	2.4	80	4	12,800
KRE-226120	2.6	12	3.9	2.5	50	4	7,500
KRE-226160	2.6	16	3.9	2.5	60	4	7,500
KRE-226200	2.6	20	3.9	2.5	60	4	7,500
KRE-226300	2.6	30	3.9	2.5	70	4	8,400
KRE-226400	2.6	40	3.9	2.5	80	4	12,800
KRE-227120	2.7	12	4	2.6	50	4	7,500
KRE-227160	2.7	16	4	2.6	60	4	7,500
KRE-227200	2.7	20	4	2.6	60	4	7,500
KRE-227300	2.7	30	4	2.6	70	4	8,400
KRE-227400	2.7	40	4	2.6	80	4	12,800
KRE-228120	2.8	12	4.2	2.7	50	4	7,500
KRE-228160	2.8	16	4.2	2.7	60	4	7,500
KRE-228200	2.8	20	4.2	2.7	60	4	7,500
KRE-228300	2.8	30	4.2	2.7	70	4	8,400
KRE-228400	2.8	40	4.2	2.7	80	4	12,800
KRE-229120	2.9	12	4.3	2.8	50	4	7,500
KRE-229160	2.9	16	4.3	2.8	60	4	7,500
KRE-229200	2.9	20	4.3	2.8	60	4	7,500
KRE-229300	2.9	30	4.3	2.8	70	4	8,400
KRE-229400	2.9	40	4.3	2.8	80	4	12,800
KRE-230120	3	12	4.5	2.9	50	6	6,400
KRE-230160	3	16	4.5	2.9	60	6	6,400
KRE-230200	3	20	4.5	2.9	60	6	6,400
KRE-230250	3	25	4.5	2.9	70	6	6,400
KRE-230300	3	30	4.5	2.9	70	6	9,900
KRE-230350	3	35	4.5	2.9	80	6	11,300

# KRE-2

品番 Code No.	刃径 D Flute Diameter	有効長 ℓ1 Effective Length	刃長 ℓ Flute Length	首下径 d1 Neck Diameter	全長 L Total Length	柄径 d Shank Diameter	標準価格 Retail Price
KRE-230400	3	40	4.5	2.9	80	6	12,800
KRE-230450	3	45	4.5	2.9	100	6	14,100
KRE-230500	3	50	4.5	2.9	100	6	15,900
KRE-231200	3.1	20	4.6	3	60	6	9,300
KRE-231250	3.1	25	4.6	3	70	6	9,300
KRE-231300	3.1	30	4.6	3	70	6	9,300
KRE-231400	3.1	40	4.6	3	80	6	12,800
KRE-231500	3.1	50	4.6	3	100	6	15,900
KRE-232200	3.2	20	4.8	3.1	60	6	9,300
KRE-232250	3.2	25	4.8	3.1	70	6	9,300
KRE-232300	3.2	30	4.8	3.1	70	6	9,300
KRE-232400	3.2	40	4.8	3.1	80	6	12,800
KRE-232500	3.2	50	4.8	3.1	100	6	15,900
KRE-233200	3.3	20	4.9	3.2	60	6	9,300
KRE-233250	3.3	25	4.9	3.2	70	6	9,300
KRE-233300	3.3	30	4.9	3.2	70	6	9,300
KRE-233400	3.3	40	4.9	3.2	80	6	12,800
KRE-233500	3.3	50	4.9	3.2	100	6	15,900
KRE-234200	3.4	20	5.1	3.3	60	6	9,300
KRE-234250	3.4	25	5.1	3.3	70	6	9,300
KRE-234300	3.4	30	5.1	3.3	70	6	9,300
KRE-234400	3.4	40	5.1	3.3	80	6	12,800
KRE-234500	3.4	50	5.1	3.3	100	6	15,900
KRE-235200	3.5	20	5.2	3.35	60	6	7,500
KRE-235250	3.5	25	5.2	3.35	70	6	7,500
KRE-235300	3.5	30	5.2	3.35	70	6	7,700
KRE-235400	3.5	40	5.2	3.35	80	6	10,600
KRE-235500	3.5	50	5.2	3.35	100	6	12,800
KRE-236200	3.6	20	5.4	3.45	60	6	9,600
KRE-236250	3.6	25	5.4	3.45	70	6	9,600
KRE-236300	3.6	30	5.4	3.45	70	6	9,600
KRE-236400	3.6	40	5.4	3.45	80	6	12,800
KRE-236500	3.6	50	5.4	3.45	100	6	15,900
KRE-237200	3.7	20	5.5	3.55	60	6	9,600
KRE-237250	3.7	25	5.5	3.55	70	6	9,600
KRE-237300	3.7	30	5.5	3.55	70	6	9,600
KRE-237400	3.7	40	5.5	3.55	80	6	12,800
KRE-237500	3.7	50	5.5	3.55	100	6	15,900
KRE-238200	3.8	20	5.7	3.65	60	6	9,600
KRE-238250	3.8	25	5.7	3.65	70	6	9,600
KRE-238300	3.8	30	5.7	3.65	70	6	9,600
KRE-238400	3.8	40	5.7	3.65	80	6	12,800
KRE-238500	3.8	50	5.7	3.65	100	6	15,900
KRE-239200	3.9	20	5.8	3.75	60	6	9,600
KRE-239250	3.9	25	5.8	3.75	70	6	9,600
KRE-239300	3.9	30	5.8	3.75	70	6	9,600
KRE-239400	3.9	40	5.8	3.75	80	6	12,800
KRE-239500	3.9	50	5.8	3.75	100	6	15,900

品番 Code No.	刃径 D Flute Diameter	有効長 ℓ1 Effective Length	刃長 ℓ Flute Length	首下径 d1 Neck Diameter	全長 L Total Length	柄径 d Shank Diameter	標準価格 Retail Price
KRE-240200	4	20	6	3.8	60	6	7,400
KRE-240250	4	25	6	3.8	70	6	7,400
KRE-240300	4	30	6	3.8	70	6	7,900
KRE-240350	4	35	6	3.8	80	6	8,500
KRE-240400	4	40	6	3.8	80	6	10,600
KRE-240500	4	50	6	3.8	100	6	14,900
KRE-240600	4	60	6	3.8	120	6	15,900
KRE-241200	4.1	20	6.1	3.9	60	6	10,600
KRE-241250	4.1	25	6.1	3.9	70	6	10,600
KRE-241300	4.1	30	6.1	3.9	70	6	10,600
KRE-241400	4.1	40	6.1	3.9	80	6	13,800
KRE-241500	4.1	50	6.1	3.9	100	6	17,000
KRE-242200	4.2	20	6.3	4	60	6	10,600
KRE-242250	4.2	25	6.3	4	70	6	10,600
KRE-242300	4.2	30	6.3	4	70	6	10,600
KRE-242400	4.2	40	6.3	4	80	6	13,800
KRE-242500	4.2	50	6.3	4	100	6	17,000
KRE-243200	4.3	20	6.4	4.1	60	6	10,600
KRE-243250	4.3	25	6.4	4.1	70	6	10,600
KRE-243300	4.3	30	6.4	4.1	70	6	10,600
KRE-243400	4.3	40	6.4	4.1	80	6	13,800
KRE-243500	4.3	50	6.4	4.1	100	6	17,000
KRE-244200	4.4	20	6.6	4.2	60	6	10,600
KRE-244250	4.4	25	6.6	4.2	70	6	10,600
KRE-244300	4.4	30	6.6	4.2	70	6	10,600
KRE-244400	4.4	40	6.6	4.2	80	6	13,800
KRE-244500	4.4	50	6.6	4.2	100	6	17,000
KRE-245200	4.5	20	6.7	4.3	60	6	10,600
KRE-245250	4.5	25	6.7	4.3	70	6	10,600
KRE-245300	4.5	30	6.7	4.3	70	6	10,600
KRE-245400	4.5	40	6.7	4.3	80	6	13,800
KRE-245500	4.5	50	6.7	4.3	100	6	17,000
KRE-246200	4.6	20	6.9	4.4	60	6	10,600
KRE-246250	4.6	25	6.9	4.4	70	6	10,600
KRE-246300	4.6	30	6.9	4.4	70	6	10,600
KRE-246400	4.6	40	6.9	4.4	80	6	13,800
KRE-246500	4.6	50	6.9	4.4	100	6	17,000
KRE-247200	4.7	20	7	4.5	60	6	10,600
KRE-247250	4.7	25	7	4.5	70	6	10,600
KRE-247300	4.7	30	7	4.5	70	6	10,600
KRE-247400	4.7	40	7	4.5	80	6	13,800
KRE-247500	4.7	50	7	4.5	100	6	17,000
KRE-248200	4.8	20	7.2	4.6	60	6	10,600
KRE-248250	4.8	25	7.2	4.6	70	6	10,600
KRE-248300	4.8	30	7.2	4.6	70	6	10,600
KRE-248400	4.8	40	7.2	4.6	80	6	13,800
KRE-248500	4.8	50	7.2	4.6	100	6	17,000
KRE-249200	4.9	20	7.3	4.7	60	6	10,600

超硬製品

Tungsten Carbide







# KTBL-2

超硬テーパネックボールエンドミル  
Tungsten Carbide Taper Neck Ball Endmill

- 首部をテーパにして有効長を長くしました  
Long effective length with taper neck
- 深彫り加工などに最適です  
Suitable for deep processing

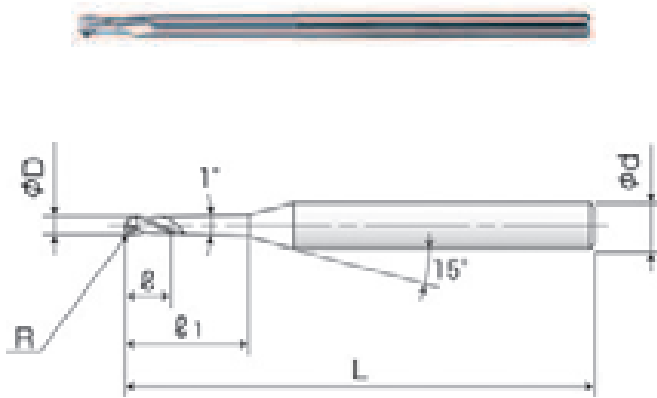

超微粒子合金 Micro Grain Tungsten Carbide



刃径の許容差 Flute Diameter Tolerance  
D 0~-0.01



柄径の許容差 Shank Diameter Tolerance  
d=6 0~-0.008  
d=8 0~-0.009



ネジレ角30° Twist Angle 30°



R許容差 R Tolerance  
+0.01~-0.01

- 切削条件表はP213に記載
- Cutting conditions are recommended on page 213.

単位 [寸法: mm / 価格: 円]  
Unit [size: mm / Retail Price: JPY]

品番 Code No.	R	刃径 D Flute Diameter	有効長 l1 Effective Length	刃長 l Flute Length	首部勾配 Neck Taper	全長 L Total Length	柄径 d Shank Diameter	標準価格 Retail Price
KTBL-2R0110	R 0.1	0.2	10	0.4	1° (両角)	100	6	19,100
KTBL-2R0120	R 0.1	0.2	20	0.4	1° (両角)	100	6	20,500
KTBL-2R0151	R 0.15	0.3	10	0.6	1° (両角)	100	6	18,400
KTBL-2R0152	R 0.15	0.3	20	0.6	1° (両角)	100	6	19,800
KTBL-2R0210	R 0.2	0.4	10	0.8	1° (両角)	100	6	16,300
KTBL-2R0220	R 0.2	0.4	20	0.8	1° (両角)	100	6	17,300
KTBL-2R0251	R 0.25	0.5	10	1	1° (両角)	100	6	15,900
KTBL-2R0252	R 0.25	0.5	20	1	1° (両角)	100	6	17,000
KTBL-2R0310	R 0.3	0.6	10	1.5	1° (両角)	100	6	14,900
KTBL-2R0320	R 0.3	0.6	20	1.5	1° (両角)	100	6	15,900
KTBL-2R0410	R 0.4	0.8	10	2	1° (両角)	100	6	14,900
KTBL-2R0420	R 0.4	0.8	20	2	1° (両角)	100	6	15,900
KTBL-2R0530	R 0.5	1	30	3	1° (両角)	100	6	14,900
KTBL-2R0540	R 0.5	1	40	3	1° (両角)	100	6	14,900
KTBL-2R1040	R 1	2	40	6	1° (両角)	110	6	14,900
KTBL-2R1050	R 1	2	50	6	1° (両角)	110	6	15,900
KTBL-2R1540	R 1.5	3	40	9	1° (両角)	120	6	15,900
KTBL-2R1550	R 1.5	3	50	9	1° (両角)	120	6	17,000
KTBL-2R2040	R 2	4	40	10	1° (両角)	120	6	16,600
KTBL-2R2050	R 2	4	50	10	1° (両角)	120	6	17,300
KTBL-2R2060	R 2	4	60	10	1° (両角)	120	6	18,400
KTBL-2R2540	R 2.5	5	40	12	1° (両角)	120	6	16,600
KTBL-2R2550	R 2.5	5	50	12	1° (両角)	120	6	17,300
KTBL-2R2560	R 2.5	5	60	12	1° (両角)	120	6	18,400
KTBL-2R3040	R 3	6	40	14	1° (両角)	120	8	17,600
KTBL-2R3050	R 3	6	50	14	1° (両角)	120	8	18,400
KTBL-2R3060	R 3	6	60	14	1° (両角)	120	8	19,400

超硬製品

Tungsten Carbide

# KSER-2

超硬 2 枚刃コーナーR付エンドミル  
Tungsten Carbide 2 Flutes Corner R Endmill

■刃長が刃径の1倍～最大10倍までラインナップ  
Line-upped flute length 1 times to max 10 times of flute diameter

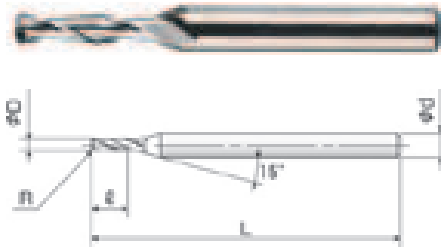

超微粒子合金 Micro Grain Tungsten Carbide



刃径の許容差 Flute Diameter Tolerance  
D 0～-0.01



柄径の許容差 Shank Diameter Tolerance  
d 0～-0.008



ネジレ角30° Twist Angle 30°



コーナーR許容差 corner R Tolerance  
+0.01～-0.01

●切削条件表はP214に記載 単位[寸法: mm/価格: 円]  
●Cutting conditions are recommended on page 214. Unit [size: mm/Retail Price: JPY]

品番 Code No.	刃径 D Flute Diameter	コーナーR Corner R	刃長 ℓ Flute Length	全長 L Total Length	柄径 d Shank Diameter	標準価格 Retail Price
KSER-210005010	1	R0.05	1	50	4	7,800
KSER-210005020	1	R0.05	2	50	4	7,800
KSER-210005030	1	R0.05	3	50	4	7,800
KSER-210005040	1	R0.05	4	50	4	8,500
KSER-210005050	1	R0.05	5	50	4	9,300
KSER-210005060	1	R0.05	6	50	4	10,300
KSER-210005070	1	R0.05	7	50	4	10,600
KSER-210005080	1	R0.05	8	50	4	11,400
KSER-210005090	1	R0.05	9	50	4	12,500
KSER-210005100	1	R0.05	10	50	4	12,800
KSER-210010010	1	R0.1	1	50	4	7,800
KSER-210010020	1	R0.1	2	50	4	7,800
KSER-210010030	1	R0.1	3	50	4	7,800
KSER-210010040	1	R0.1	4	50	4	8,500
KSER-210010050	1	R0.1	5	50	4	9,300
KSER-210010060	1	R0.1	6	50	4	10,300
KSER-210010070	1	R0.1	7	50	4	10,600
KSER-210010080	1	R0.1	8	50	4	11,400
KSER-210010090	1	R0.1	9	50	4	12,500
KSER-210010100	1	R0.1	10	50	4	12,800
KSER-210020010	1	R0.2	1	50	4	7,800
KSER-210020020	1	R0.2	2	50	4	7,800

品番 Code No.	刃径 D Flute Diameter	コーナーR Corner R	刃長 ℓ Flute Length	全長 L Total Length	柄径 d Shank Diameter	標準価格 Retail Price
KSER-210020030	1	R0.2	3	50	4	7,800
KSER-210020040	1	R0.2	4	50	4	8,500
KSER-210020050	1	R0.2	5	50	4	9,300
KSER-210020060	1	R0.2	6	50	4	10,300
KSER-210020070	1	R0.2	7	50	4	10,600
KSER-210020080	1	R0.2	8	50	4	11,400
KSER-210020090	1	R0.2	9	50	4	12,500
KSER-210020100	1	R0.2	10	50	4	12,800
KSER-210030010	1	R0.3	1	50	4	7,800
KSER-210030020	1	R0.3	2	50	4	7,800
KSER-210030030	1	R0.3	3	50	4	7,800
KSER-210030040	1	R0.3	4	50	4	8,500
KSER-210030050	1	R0.3	5	50	4	9,300
KSER-210030060	1	R0.3	6	50	4	10,300
KSER-210030070	1	R0.3	7	50	4	10,600
KSER-210030080	1	R0.3	8	50	4	11,400
KSER-210030090	1	R0.3	9	50	4	12,500
KSER-210030100	1	R0.3	10	50	4	12,800
KSER-215005020	1.5	R0.05	2	50	4	7,800
KSER-215005040	1.5	R0.05	4	50	4	7,800
KSER-215005060	1.5	R0.05	6	50	4	9,300
KSER-215005080	1.5	R0.05	8	50	4	10,600
KSER-215005100	1.5	R0.05	10	50	4	11,400
KSER-215005120	1.5	R0.05	12	50	4	12,500
KSER-215005150	1.5	R0.05	15	50	4	13,500
KSER-215010020	1.5	R0.1	2	50	4	7,800
KSER-215010040	1.5	R0.1	4	50	4	7,800
KSER-215010060	1.5	R0.1	6	50	4	9,300
KSER-215010080	1.5	R0.1	8	50	4	10,600
KSER-215010100	1.5	R0.1	10	50	4	11,400
KSER-215010120	1.5	R0.1	12	50	4	12,500
KSER-215010150	1.5	R0.1	15	50	4	13,500
KSER-215020020	1.5	R0.2	2	50	4	7,800
KSER-215020040	1.5	R0.2	4	50	4	7,800
KSER-215020060	1.5	R0.2	6	50	4	9,300
KSER-215020080	1.5	R0.2	8	50	4	10,600
KSER-215020100	1.5	R0.2	10	50	4	11,400
KSER-215020120	1.5	R0.2	12	50	4	12,500
KSER-215020150	1.5	R0.2	15	50	4	13,500
KSER-215030020	1.5	R0.3	2	50	4	7,800
KSER-215030040	1.5	R0.3	4	50	4	7,800
KSER-215030060	1.5	R0.3	6	50	4	9,300
KSER-215030080	1.5	R0.3	8	50	4	10,600
KSER-215030100	1.5	R0.3	10	50	4	11,400
KSER-215030120	1.5	R0.3	12	50	4	12,500
KSER-215030150	1.5	R0.3	15	50	4	13,500
KSER-215050020	1.5	R0.5	2	50	4	7,800
KSER-215050040	1.5	R0.5	4	50	4	7,800

超硬製品

Tungsten Carbide

# KSER-2

品番 Code No.	刃径 D Flute Diameter	コーナー R Corner R	刃長 ℓ Flute Length	全長 L Total Length	柄径 d Shank Diameter	標準価格 Retail Price
KSER-215050060	1.5	R0.5	6	50	4	9,300
KSER-215050080	1.5	R0.5	8	50	4	10,600
KSER-215050100	1.5	R0.5	10	50	4	11,400
KSER-215050120	1.5	R0.5	12	50	4	12,500
KSER-215050150	1.5	R0.5	15	50	4	13,500
KSER-22005020	2	R0.05	2	50	4	7,800
KSER-22005040	2	R0.05	4	50	4	7,800
KSER-22005060	2	R0.05	6	50	4	7,800
KSER-22005080	2	R0.05	8	50	4	8,500
KSER-22005100	2	R0.05	10	50	4	9,300
KSER-22005120	2	R0.05	12	50	4	10,000
KSER-22005140	2	R0.05	14	50	4	10,600
KSER-22005160	2	R0.05	16	60	4	11,400
KSER-22005180	2	R0.05	18	60	4	12,500
KSER-22005200	2	R0.05	20	60	4	13,500
KSER-220010020	2	R0.1	2	50	4	7,800
KSER-220010040	2	R0.1	4	50	4	7,800
KSER-220010060	2	R0.1	6	50	4	7,800
KSER-220010080	2	R0.1	8	50	4	8,500
KSER-220010100	2	R0.1	10	50	4	9,300
KSER-220010120	2	R0.1	12	50	4	10,000
KSER-220010140	2	R0.1	14	50	4	10,600
KSER-220010160	2	R0.1	16	60	4	11,400
KSER-220010180	2	R0.1	18	60	4	12,500
KSER-220010200	2	R0.1	20	60	4	13,500
KSER-220020020	2	R0.2	2	50	4	7,800
KSER-220020040	2	R0.2	4	50	4	7,800
KSER-220020060	2	R0.2	6	50	4	7,800
KSER-220020080	2	R0.2	8	50	4	8,500
KSER-220020100	2	R0.2	10	50	4	9,300
KSER-220020120	2	R0.2	12	50	4	10,000
KSER-220020140	2	R0.2	14	50	4	10,600
KSER-220020160	2	R0.2	16	60	4	11,400
KSER-220020180	2	R0.2	18	60	4	12,500
KSER-220020200	2	R0.2	20	60	4	13,500
KSER-220030020	2	R0.3	2	50	4	7,800
KSER-220030040	2	R0.3	4	50	4	7,800
KSER-220030060	2	R0.3	6	50	4	7,800
KSER-220030080	2	R0.3	8	50	4	8,500
KSER-220030100	2	R0.3	10	50	4	9,300
KSER-220030120	2	R0.3	12	50	4	10,000
KSER-220030140	2	R0.3	14	50	4	10,600
KSER-220030160	2	R0.3	16	60	4	11,400
KSER-220030180	2	R0.3	18	60	4	12,500
KSER-220030200	2	R0.3	20	60	4	13,500
KSER-220050020	2	R0.5	2	50	4	7,800
KSER-220050040	2	R0.5	4	50	4	7,800
KSER-220050060	2	R0.5	6	50	4	7,800

品番 Code No.	刃径 D Flute Diameter	コーナー R Corner R	刃長 ℓ Flute Length	全長 L Total Length	柄径 d Shank Diameter	標準価格 Retail Price
KSER-220050080	2	R0.5	8	50	4	8,500
KSER-220050100	2	R0.5	10	50	4	9,300
KSER-220050120	2	R0.5	12	50	4	10,000
KSER-220050140	2	R0.5	14	50	4	10,600
KSER-220050160	2	R0.5	16	60	4	11,400
KSER-220050180	2	R0.5	18	60	4	12,500
KSER-220050200	2	R0.5	20	60	4	13,500
KSER-230005030	3	R0.05	3	50	6	8,500
KSER-230005060	3	R0.05	6	50	6	8,500
KSER-230005090	3	R0.05	9	50	6	8,500
KSER-230005120	3	R0.05	12	50	6	9,200
KSER-230005150	3	R0.05	15	60	6	10,000
KSER-230005180	3	R0.05	18	60	6	10,600
KSER-230005210	3	R0.05	21	60	6	11,400
KSER-230005250	3	R0.05	25	70	6	12,500
KSER-230005300	3	R0.05	30	70	6	13,500
KSER-230010030	3	R0.1	3	50	6	8,500
KSER-230010060	3	R0.1	6	50	6	8,500
KSER-230010090	3	R0.1	9	50	6	8,500
KSER-230010120	3	R0.1	12	50	6	9,200
KSER-230010150	3	R0.1	15	60	6	10,000
KSER-230010180	3	R0.1	18	60	6	10,600
KSER-230010210	3	R0.1	21	60	6	11,400
KSER-230010250	3	R0.1	25	70	6	12,500
KSER-230010300	3	R0.1	30	70	6	13,500
KSER-230020030	3	R0.2	3	50	6	8,500
KSER-230020060	3	R0.2	6	50	6	8,500
KSER-230020090	3	R0.2	9	50	6	8,500
KSER-230020120	3	R0.2	12	50	6	9,200
KSER-230020150	3	R0.2	15	60	6	10,000
KSER-230020180	3	R0.2	18	60	6	10,600
KSER-230020210	3	R0.2	21	60	6	11,400
KSER-230020250	3	R0.2	25	70	6	12,500
KSER-230020300	3	R0.2	30	70	6	13,500
KSER-230030030	3	R0.3	3	50	6	8,500
KSER-230030060	3	R0.3	6	50	6	8,500
KSER-230030090	3	R0.3	9	50	6	8,500
KSER-230030120	3	R0.3	12	50	6	9,200
KSER-230030150	3	R0.3	15	60	6	10,000
KSER-230030180	3	R0.3	18	60	6	10,600
KSER-230030210	3	R0.3	21	60	6	11,400
KSER-230030250	3	R0.3	25	70	6	12,500
KSER-230030300	3	R0.3	30	70	6	13,500
KSER-230050030	3	R0.5	3	50	6	8,500
KSER-230050060	3	R0.5	6	50	6	8,500
KSER-230050090	3	R0.5	9	50	6	8,500
KSER-230050120	3	R0.5	12	50	6	9,200
KSER-230050150	3	R0.5	15	60	6	10,000

超硬製品

Tungsten Carbide









# KSR-2

超硬 2枚刃コーナーR付エンドミル  
Tungsten Carbide 2 Flutes Corner R Endmill

■コーナーRを用途に合わせてきめ細かく揃えました  
Line-upped various sizes according to the use

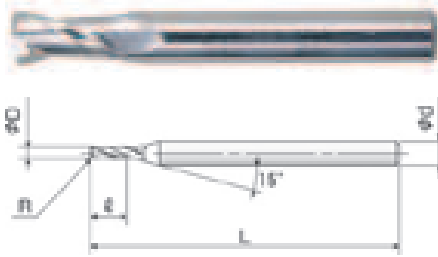

超微粒子合金 Micro Grain Tungsten Carbide



刃径の許容差 Flute Diameter Tolerance  
D 0~-0.01



柄径の許容差 Shank Diameter Tolerance  
d 0~-0.008



ネジレ角30° Twist Angle 30°



コーナーR許容差 corner R Tolerance  
+0.01~-0.01

●切削条件表はP217に記載 単位[寸法: mm / 価格: 円]  
●Cutting conditions are recommended on page 217. Unit [size: mm / Retail Price: JPY]

品番 Code No.	刃径 D Flute Diameter	コーナーR Corner R	刃長 ℓ Flute Length	全長 L Total Length	柄径 d Shank Diameter	標準価格 Retail Price
KSR-210010R	1	R0.1	3	40	4	7,800
KSR-210015R	1	R0.15	3	40	4	7,800
KSR-210020R	1	R0.2	3	40	4	7,800
KSR-210025R	1	R0.25	3	40	4	7,800
KSR-210030R	1	R0.3	3	40	4	7,800
KSR-211010R	1.1	R0.1	3	40	4	8,500
KSR-211015R	1.1	R0.15	3	40	4	8,500
KSR-211020R	1.1	R0.2	3	40	4	8,500
KSR-211025R	1.1	R0.25	3	40	4	8,500
KSR-211030R	1.1	R0.3	3	40	4	8,500
KSR-212010R	1.2	R0.1	3	40	4	8,500
KSR-212015R	1.2	R0.15	3	40	4	8,500
KSR-212020R	1.2	R0.2	3	40	4	8,500
KSR-212025R	1.2	R0.25	3	40	4	8,500
KSR-212030R	1.2	R0.3	3	40	4	8,500
KSR-213010R	1.3	R0.1	3	40	4	8,500
KSR-213015R	1.3	R0.15	3	40	4	8,500
KSR-213020R	1.3	R0.2	3	40	4	8,500
KSR-213025R	1.3	R0.25	3	40	4	8,500
KSR-213030R	1.3	R0.3	3	40	4	8,500
KSR-214010R	1.4	R0.1	3	40	4	8,500
KSR-214015R	1.4	R0.15	3	40	4	8,500

品番 Code No.	刃径 D Flute Diameter	コーナーR Corner R	刃長 ℓ Flute Length	全長 L Total Length	柄径 d Shank Diameter	標準価格 Retail Price
KSR-214020R	1.4	R0.2	3	40	4	8,500
KSR-214025R	1.4	R0.25	3	40	4	8,500
KSR-214030R	1.4	R0.3	3	40	4	8,500
KSR-215010R	1.5	R0.1	4	40	4	7,000
KSR-215015R	1.5	R0.15	4	40	4	7,800
KSR-215020R	1.5	R0.2	4	40	4	7,000
KSR-215025R	1.5	R0.25	4	40	4	7,800
KSR-215030R	1.5	R0.3	4	40	4	7,000
KSR-216010R	1.6	R0.1	4	40	4	7,800
KSR-216015R	1.6	R0.15	4	40	4	7,800
KSR-216020R	1.6	R0.2	4	40	4	7,800
KSR-216025R	1.6	R0.25	4	40	4	7,800
KSR-216030R	1.6	R0.3	4	40	4	7,800
KSR-217010R	1.7	R0.1	4	40	4	7,800
KSR-217015R	1.7	R0.15	4	40	4	7,800
KSR-217020R	1.7	R0.2	4	40	4	7,800
KSR-217025R	1.7	R0.25	4	40	4	7,800
KSR-217030R	1.7	R0.3	4	40	4	7,800
KSR-218010R	1.8	R0.1	4	40	4	7,800
KSR-218015R	1.8	R0.15	4	40	4	7,800
KSR-218020R	1.8	R0.2	4	40	4	7,800
KSR-218025R	1.8	R0.25	4	40	4	7,800
KSR-218030R	1.8	R0.3	4	40	4	7,800
KSR-219010R	1.9	R0.1	4	40	4	7,800
KSR-219015R	1.9	R0.15	4	40	4	7,800
KSR-219020R	1.9	R0.2	4	40	4	7,800
KSR-219025R	1.9	R0.25	4	40	4	7,800
KSR-219030R	1.9	R0.3	4	40	4	7,800
KSR-220010R	2	R0.1	6	40	4	7,000
KSR-220015R	2	R0.15	6	40	4	7,800
KSR-220020R	2	R0.2	6	40	4	7,000
KSR-220025R	2	R0.25	6	40	4	7,800
KSR-220030R	2	R0.3	6	40	4	7,000
KSR-220035R	2	R0.35	6	40	4	7,800
KSR-220040R	2	R0.4	6	40	4	7,800
KSR-220045R	2	R0.45	6	40	4	7,800
KSR-220050R	2	R0.5	6	40	4	7,000
KSR-221010R	2.1	R0.1	6	40	4	7,800
KSR-221015R	2.1	R0.15	6	40	4	7,800
KSR-221020R	2.1	R0.2	6	40	4	7,800
KSR-221025R	2.1	R0.25	6	40	4	7,800
KSR-221030R	2.1	R0.3	6	40	4	7,800
KSR-221035R	2.1	R0.35	6	40	4	7,800
KSR-221040R	2.1	R0.4	6	40	4	7,800
KSR-221050R	2.1	R0.5	6	40	4	7,800
KSR-222010R	2.2	R0.1	6	40	4	7,800
KSR-222015R	2.2	R0.15	6	40	4	7,800
KSR-222020R	2.2	R0.2	6	40	4	7,800

超硬製品

Tungsten Carbide

# KSR-2

品番 Code No.	刃径 D Flute Diameter	コーナーR Corner R	刃長 ℓ Flute Length	全長 L Total Length	柄径 d Shank Diameter	標準価格 Retail Price
KSR-222025R	2.2	R0.25	6	40	4	7,800
KSR-222030R	2.2	R0.3	6	40	4	7,800
KSR-222035R	2.2	R0.35	6	40	4	7,800
KSR-222040R	2.2	R0.4	6	40	4	7,800
KSR-222050R	2.2	R0.5	6	40	4	7,800
KSR-223010R	2.3	R0.1	6	40	4	7,800
KSR-223015R	2.3	R0.15	6	40	4	7,800
KSR-223020R	2.3	R0.2	6	40	4	7,800
KSR-223025R	2.3	R0.25	6	40	4	7,800
KSR-223030R	2.3	R0.3	6	40	4	7,800
KSR-223035R	2.3	R0.35	6	40	4	7,800
KSR-223040R	2.3	R0.4	6	40	4	7,800
KSR-223050R	2.3	R0.5	6	40	4	7,800
KSR-224010R	2.4	R0.1	6	40	4	7,800
KSR-224015R	2.4	R0.15	6	40	4	7,800
KSR-224020R	2.4	R0.2	6	40	4	7,800
KSR-224025R	2.4	R0.25	6	40	4	7,800
KSR-224030R	2.4	R0.3	6	40	4	7,800
KSR-224035R	2.4	R0.35	6	40	4	7,800
KSR-224040R	2.4	R0.4	6	40	4	7,800
KSR-224050R	2.4	R0.5	6	40	4	7,800
KSR-225010R	2.5	R0.1	8	40	4	7,800
KSR-225015R	2.5	R0.15	8	40	4	8,500
KSR-225020R	2.5	R0.2	8	40	4	7,800
KSR-225025R	2.5	R0.25	8	40	4	8,500
KSR-225030R	2.5	R0.3	8	40	4	7,800
KSR-225035R	2.5	R0.35	8	40	4	8,500
KSR-225040R	2.5	R0.4	8	40	4	8,500
KSR-225045R	2.5	R0.45	8	40	4	8,500
KSR-225050R	2.5	R0.5	8	40	4	7,800
KSR-226010R	2.6	R0.1	8	40	4	8,200
KSR-226015R	2.6	R0.15	8	40	4	8,200
KSR-226020R	2.6	R0.2	8	40	4	8,200
KSR-226025R	2.6	R0.25	8	40	4	8,200
KSR-226030R	2.6	R0.3	8	40	4	8,200
KSR-226035R	2.6	R0.35	8	40	4	8,200
KSR-226040R	2.6	R0.4	8	40	4	8,200
KSR-226050R	2.6	R0.5	8	40	4	8,200
KSR-227010R	2.7	R0.1	8	40	4	8,200
KSR-227015R	2.7	R0.15	8	40	4	8,200
KSR-227020R	2.7	R0.2	8	40	4	8,200
KSR-227025R	2.7	R0.25	8	40	4	8,200
KSR-227030R	2.7	R0.3	8	40	4	8,200
KSR-227035R	2.7	R0.35	8	40	4	8,200
KSR-227040R	2.7	R0.4	8	40	4	8,200
KSR-227050R	2.7	R0.5	8	40	4	8,200
KSR-228010R	2.8	R0.1	8	40	4	8,200
KSR-228015R	2.8	R0.15	8	40	4	8,200

品番 Code No.	刃径 D Flute Diameter	コーナーR Corner R	刃長 ℓ Flute Length	全長 L Total Length	柄径 d Shank Diameter	標準価格 Retail Price
KSR-228020R	2.8	R0.2	8	40	4	8,200
KSR-228025R	2.8	R0.25	8	40	4	8,200
KSR-228030R	2.8	R0.3	8	40	4	8,200
KSR-228035R	2.8	R0.35	8	40	4	8,200
KSR-228040R	2.8	R0.4	8	40	4	8,200
KSR-228050R	2.8	R0.5	8	40	4	8,200
KSR-229010R	2.9	R0.1	8	40	4	8,200
KSR-229015R	2.9	R0.15	8	40	4	8,200
KSR-229020R	2.9	R0.2	8	40	4	8,200
KSR-229025R	2.9	R0.25	8	40	4	8,200
KSR-229030R	2.9	R0.3	8	40	4	8,200
KSR-229035R	2.9	R0.35	8	40	4	8,200
KSR-229040R	2.9	R0.4	8	40	4	8,200
KSR-229050R	2.9	R0.5	8	40	4	8,200
KSR-230010R	3	R0.1	8	45	6	8,300
KSR-230015R	3	R0.15	8	45	6	9,100
KSR-230020R	3	R0.2	8	45	6	8,300
KSR-230025R	3	R0.25	8	45	6	9,100
KSR-230030R	3	R0.3	8	45	6	8,300
KSR-230035R	3	R0.35	8	45	6	9,100
KSR-230040R	3	R0.4	8	45	6	8,300
KSR-230045R	3	R0.45	8	45	6	9,100
KSR-230050R	3	R0.5	8	45	6	10,100
KSR-230075R	3	R0.75	8	45	6	10,100
KSR-230100R	3	R1	8	45	6	9,200
KSR-231010R	3.1	R0.1	8	45	6	8,900
KSR-231015R	3.1	R0.15	8	45	6	8,900
KSR-231020R	3.1	R0.2	8	45	6	8,900
KSR-231025R	3.1	R0.25	8	45	6	8,900
KSR-231030R	3.1	R0.3	8	45	6	8,900
KSR-231035R	3.1	R0.35	8	45	6	8,900
KSR-231040R	3.1	R0.4	8	45	6	8,900
KSR-231050R	3.1	R0.5	8	45	6	8,900
KSR-231075R	3.1	R0.75	8	45	6	8,900
KSR-231100R	3.1	R1	8	45	6	8,900
KSR-232010R	3.2	R0.1	8	45	6	8,900
KSR-232015R	3.2	R0.15	8	45	6	8,900
KSR-232020R	3.2	R0.2	8	45	6	8,900
KSR-232025R	3.2	R0.25	8	45	6	8,900
KSR-232030R	3.2	R0.3	8	45	6	8,900
KSR-232035R	3.2	R0.35	8	45	6	8,900
KSR-232040R	3.2	R0.4	8	45	6	8,900
KSR-232050R	3.2	R0.5	8	45	6	8,900
KSR-232075R	3.2	R0.75	8	45	6	8,900
KSR-232100R	3.2	R1	8	45	6	8,900
KSR-233010R	3.3	R0.1	8	45	6	8,900
KSR-233015R	3.3	R0.15	8	45	6	8,900
KSR-233020R	3.3	R0.2	8	45	6	8,900

超硬製品

Tungsten Carbide

# KSR-2

品番 Code No.	刃径 D Flute Diameter	コーナー R Corner R	刃長 ℓ Flute Length	全長 L Total Length	柄径 d Shank Diameter	標準価格 Retail Price
KSR-233025R	3.3	R0.25	8	45	6	8,900
KSR-233030R	3.3	R0.3	8	45	6	8,900
KSR-233035R	3.3	R0.35	8	45	6	8,900
KSR-233040R	3.3	R0.4	8	45	6	8,900
KSR-233050R	3.3	R0.5	8	45	6	8,900
KSR-233075R	3.3	R0.75	8	45	6	8,900
KSR-233100R	3.3	R1	8	45	6	8,900
KSR-234010R	3.4	R0.1	8	45	6	8,900
KSR-234015R	3.4	R0.15	8	45	6	8,900
KSR-234020R	3.4	R0.2	8	45	6	8,900
KSR-234025R	3.4	R0.25	8	45	6	8,900
KSR-234030R	3.4	R0.3	8	45	6	8,900
KSR-234035R	3.4	R0.35	8	45	6	8,900
KSR-234040R	3.4	R0.4	8	45	6	8,900
KSR-234050R	3.4	R0.5	8	45	6	8,900
KSR-234075R	3.4	R0.75	8	45	6	8,900
KSR-234100R	3.4	R1	8	45	6	8,900
KSR-235010R	3.5	R0.1	8	45	6	8,900
KSR-235015R	3.5	R0.15	8	45	6	8,900
KSR-235020R	3.5	R0.2	8	45	6	8,900
KSR-235025R	3.5	R0.25	8	45	6	8,900
KSR-235030R	3.5	R0.3	8	45	6	8,900
KSR-235035R	3.5	R0.35	8	45	6	8,900
KSR-235040R	3.5	R0.4	8	45	6	8,900
KSR-235050R	3.5	R0.5	8	45	6	8,900
KSR-235075R	3.5	R0.75	8	45	6	8,900
KSR-235100R	3.5	R1	8	45	6	8,900
KSR-236010R	3.6	R0.1	8	45	6	8,900
KSR-236015R	3.6	R0.15	8	45	6	8,900
KSR-236020R	3.6	R0.2	8	45	6	8,900
KSR-236025R	3.6	R0.25	8	45	6	8,900
KSR-236030R	3.6	R0.3	8	45	6	8,900
KSR-236035R	3.6	R0.35	8	45	6	8,900
KSR-236040R	3.6	R0.4	8	45	6	8,900
KSR-236050R	3.6	R0.5	8	45	6	8,900
KSR-236075R	3.6	R0.75	8	45	6	8,900
KSR-236100R	3.6	R1	8	45	6	8,900
KSR-237010R	3.7	R0.1	8	45	6	8,900
KSR-237015R	3.7	R0.15	8	45	6	8,900
KSR-237020R	3.7	R0.2	8	45	6	8,900
KSR-237025R	3.7	R0.25	8	45	6	8,900
KSR-237030R	3.7	R0.3	8	45	6	8,900
KSR-237035R	3.7	R0.35	8	45	6	8,900
KSR-237040R	3.7	R0.4	8	45	6	8,900
KSR-237050R	3.7	R0.5	8	45	6	8,900
KSR-237075R	3.7	R0.75	8	45	6	8,900
KSR-237100R	3.7	R1	8	45	6	8,900
KSR-238010R	3.8	R0.1	8	45	6	8,900

品番 Code No.	刃径 D Flute Diameter	コーナー R Corner R	刃長 ℓ Flute Length	全長 L Total Length	柄径 d Shank Diameter	標準価格 Retail Price
KSR-238015R	3.8	R0.15	8	45	6	8,900
KSR-238020R	3.8	R0.2	8	45	6	8,900
KSR-238025R	3.8	R0.25	8	45	6	8,900
KSR-238030R	3.8	R0.3	8	45	6	8,900
KSR-238035R	3.8	R0.35	8	45	6	8,900
KSR-238040R	3.8	R0.4	8	45	6	8,900
KSR-238050R	3.8	R0.5	8	45	6	8,900
KSR-238075R	3.8	R0.75	8	45	6	8,900
KSR-238100R	3.8	R1	8	45	6	8,900
KSR-239010R	3.9	R0.1	8	45	6	8,900
KSR-239015R	3.9	R0.15	8	45	6	8,900
KSR-239020R	3.9	R0.2	8	45	6	8,900
KSR-239025R	3.9	R0.25	8	45	6	8,900
KSR-239030R	3.9	R0.3	8	45	6	8,900
KSR-239035R	3.9	R0.35	8	45	6	8,900
KSR-239040R	3.9	R0.4	8	45	6	8,900
KSR-239050R	3.9	R0.5	8	45	6	8,900
KSR-239075R	3.9	R0.75	8	45	6	8,900
KSR-239100R	3.9	R1	8	45	6	8,900
KSR-240010R	4	R0.1	11	45	6	9,200
KSR-240015R	4	R0.15	11	45	6	10,100
KSR-240020R	4	R0.2	11	45	6	9,200
KSR-240025R	4	R0.25	11	45	6	10,100
KSR-240030R	4	R0.3	11	45	6	9,200
KSR-240035R	4	R0.35	11	45	6	10,100
KSR-240040R	4	R0.4	11	45	6	9,200
KSR-240045R	4	R0.45	11	45	6	10,100
KSR-240050R	4	R0.5	11	45	6	9,200
KSR-240075R	4	R0.75	11	45	6	10,100
KSR-240100R	4	R1	11	45	6	10,200
KSR-241010R	4.1	R0.1	11	45	6	9,500
KSR-241015R	4.1	R0.15	11	45	6	9,500
KSR-241020R	4.1	R0.2	11	45	6	9,500
KSR-241025R	4.1	R0.25	11	45	6	9,500
KSR-241030R	4.1	R0.3	11	45	6	9,500
KSR-241035R	4.1	R0.35	11	45	6	9,500
KSR-241040R	4.1	R0.4	11	45	6	9,500
KSR-241050R	4.1	R0.5	11	45	6	9,500
KSR-241075R	4.1	R0.75	11	45	6	9,500
KSR-241100R	4.1	R1	11	45	6	9,500
KSR-242010R	4.2	R0.1	11	45	6	9,500
KSR-242015R	4.2	R0.15	11	45	6	9,500
KSR-242020R	4.2	R0.2	11	45	6	9,500
KSR-242025R	4.2	R0.25	11	45	6	9,500
KSR-242030R	4.2	R0.3	11	45	6	9,500
KSR-242035R	4.2	R0.35	11	45	6	9,500
KSR-242040R	4.2	R0.4	11	45	6	9,500
KSR-242050R	4.2	R0.5	11	45	6	9,500

超硬製品

Tungsten Carbide

# KSR-2

品番 Code No.	刃径 D Flute Diameter	コーナーR Corner R	刃長 ℓ Flute Length	全長 L Total Length	柄径 d Shank Diameter	標準価格 Retail Price
KSR-242075R	4.2	R0.75	11	45	6	9,500
KSR-242100R	4.2	R1	11	45	6	9,500
KSR-243010R	4.3	R0.1	11	45	6	9,500
KSR-243015R	4.3	R0.15	11	45	6	9,500
KSR-243020R	4.3	R0.2	11	45	6	9,500
KSR-243025R	4.3	R0.25	11	45	6	9,500
KSR-243030R	4.3	R0.3	11	45	6	9,500
KSR-243035R	4.3	R0.35	11	45	6	9,500
KSR-243040R	4.3	R0.4	11	45	6	9,500
KSR-243050R	4.3	R0.5	11	45	6	9,500
KSR-243075R	4.3	R0.75	11	45	6	9,500
KSR-243100R	4.3	R1	11	45	6	9,500
KSR-244010R	4.4	R0.1	11	45	6	9,500
KSR-244015R	4.4	R0.15	11	45	6	9,500
KSR-244020R	4.4	R0.2	11	45	6	9,500
KSR-244025R	4.4	R0.25	11	45	6	9,500
KSR-244030R	4.4	R0.3	11	45	6	9,500
KSR-244035R	4.4	R0.35	11	45	6	9,500
KSR-244040R	4.4	R0.4	11	45	6	9,500
KSR-244050R	4.4	R0.5	11	45	6	9,500
KSR-244075R	4.4	R0.75	11	45	6	9,500
KSR-244100R	4.4	R1	11	45	6	9,500
KSR-245010R	4.5	R0.1	11	45	6	9,500
KSR-245015R	4.5	R0.15	11	45	6	9,500
KSR-245020R	4.5	R0.2	11	45	6	9,500
KSR-245025R	4.5	R0.25	11	45	6	9,500
KSR-245030R	4.5	R0.3	11	45	6	9,500
KSR-245035R	4.5	R0.35	11	45	6	9,500
KSR-245040R	4.5	R0.4	11	45	6	9,500
KSR-245050R	4.5	R0.5	11	45	6	9,500
KSR-245075R	4.5	R0.75	11	45	6	9,500
KSR-245100R	4.5	R1	11	45	6	9,500
KSR-246010R	4.6	R0.1	11	45	6	9,500
KSR-246015R	4.6	R0.15	11	45	6	9,500
KSR-246020R	4.6	R0.2	11	45	6	9,500
KSR-246025R	4.6	R0.25	11	45	6	9,500
KSR-246030R	4.6	R0.3	11	45	6	9,500
KSR-246035R	4.6	R0.35	11	45	6	9,500
KSR-246040R	4.6	R0.4	11	45	6	9,500
KSR-246050R	4.6	R0.5	11	45	6	9,500
KSR-246075R	4.6	R0.75	11	45	6	9,500
KSR-246100R	4.6	R1	11	45	6	9,500
KSR-247010R	4.7	R0.1	11	45	6	9,500
KSR-247015R	4.7	R0.15	11	45	6	9,500
KSR-247020R	4.7	R0.2	11	45	6	9,500
KSR-247025R	4.7	R0.25	11	45	6	9,500
KSR-247030R	4.7	R0.3	11	45	6	9,500
KSR-247035R	4.7	R0.35	11	45	6	9,500

品番 Code No.	刃径 D Flute Diameter	コーナーR Corner R	刃長 ℓ Flute Length	全長 L Total Length	柄径 d Shank Diameter	標準価格 Retail Price
KSR-247040R	4.7	R0.4	11	45	6	9,500
KSR-247050R	4.7	R0.5	11	45	6	9,500
KSR-247075R	4.7	R0.75	11	45	6	9,500
KSR-247100R	4.7	R1	11	45	6	9,500
KSR-248010R	4.8	R0.1	11	45	6	9,500
KSR-248015R	4.8	R0.15	11	45	6	9,500
KSR-248020R	4.8	R0.2	11	45	6	9,500
KSR-248025R	4.8	R0.25	11	45	6	9,500
KSR-248030R	4.8	R0.3	11	45	6	9,500
KSR-248035R	4.8	R0.35	11	45	6	9,500
KSR-248040R	4.8	R0.4	11	45	6	9,500
KSR-248050R	4.8	R0.5	11	45	6	9,500
KSR-248075R	4.8	R0.75	11	45	6	9,500
KSR-248100R	4.8	R1	11	45	6	9,500
KSR-249010R	4.9	R0.1	11	45	6	9,500
KSR-249015R	4.9	R0.15	11	45	6	9,500
KSR-249020R	4.9	R0.2	11	45	6	9,500
KSR-249025R	4.9	R0.25	11	45	6	9,500
KSR-249030R	4.9	R0.3	11	45	6	9,500
KSR-249035R	4.9	R0.35	11	45	6	9,500
KSR-249040R	4.9	R0.4	11	45	6	9,500
KSR-249050R	4.9	R0.5	11	45	6	9,500
KSR-249075R	4.9	R0.75	11	45	6	9,500
KSR-249100R	4.9	R1	11	45	6	9,500
KSR-250010R	5.0	R0.1	13	50	6	9,400
KSR-250015R	5.0	R0.15	13	50	6	9,400
KSR-250020R	5.0	R0.2	13	50	6	9,400
KSR-250025R	5.0	R0.25	13	50	6	9,400
KSR-250030R	5.0	R0.3	13	50	6	9,400
KSR-250035R	5.0	R0.35	13	50	6	9,400
KSR-250040R	5.0	R0.4	13	50	6	9,400
KSR-250050R	5.0	R0.5	13	50	6	9,400
KSR-250075R	5.0	R0.75	13	50	6	9,400
KSR-250100R	5.0	R1	13	50	6	9,400
KSR-250125R	5.0	R1.25	13	50	6	9,400
KSR-250150R	5.0	R1.5	13	50	6	9,400
KSR-251010R	5.1	R0.1	13	50	6	9,400
KSR-251015R	5.1	R0.15	13	50	6	9,400
KSR-251020R	5.1	R0.2	13	50	6	9,400
KSR-251025R	5.1	R0.25	13	50	6	9,400
KSR-251030R	5.1	R0.3	13	50	6	9,400
KSR-251035R	5.1	R0.35	13	50	6	9,400
KSR-251040R	5.1	R0.4	13	50	6	9,400
KSR-251050R	5.1	R0.5	13	50	6	9,400
KSR-251075R	5.1	R0.75	13	50	6	9,400
KSR-251100R	5.1	R1	13	50	6	9,400
KSR-251125R	5.1	R1.25	13	50	6	9,400
KSR-251150R	5.1	R1.5	13	50	6	9,400

# KSR-2

品番 Code No.	刃径 D Flute Diameter	コーナーR Corner R	刃長 ℓ Flute Length	全長 L Total Length	柄径 d Shank Diameter	標準価格 Retail Price
KSR-252010R	5.2	R0.1	13	50	6	9,400
KSR-252015R	5.2	R0.15	13	50	6	9,400
KSR-252020R	5.2	R0.2	13	50	6	9,400
KSR-252025R	5.2	R0.25	13	50	6	9,400
KSR-252030R	5.2	R0.3	13	50	6	9,400
KSR-252035R	5.2	R0.35	13	50	6	9,400
KSR-252040R	5.2	R0.4	13	50	6	9,400
KSR-252050R	5.2	R0.5	13	50	6	9,400
KSR-252075R	5.2	R0.75	13	50	6	9,400
KSR-252100R	5.2	R1	13	50	6	9,400
KSR-252125R	5.2	R1.25	13	50	6	9,400
KSR-252150R	5.2	R1.5	13	50	6	9,400
KSR-253010R	5.3	R0.1	13	50	6	9,400
KSR-253015R	5.3	R0.15	13	50	6	9,400
KSR-253020R	5.3	R0.2	13	50	6	9,400
KSR-253025R	5.3	R0.25	13	50	6	9,400
KSR-253030R	5.3	R0.3	13	50	6	9,400
KSR-253035R	5.3	R0.35	13	50	6	9,400
KSR-253040R	5.3	R0.4	13	50	6	9,400
KSR-253050R	5.3	R0.5	13	50	6	9,400
KSR-253075R	5.3	R0.75	13	50	6	9,400
KSR-253100R	5.3	R1	13	50	6	9,400
KSR-253125R	5.3	R1.25	13	50	6	9,400
KSR-253150R	5.3	R1.5	13	50	6	9,400
KSR-254010R	5.4	R0.1	13	50	6	9,400
KSR-254015R	5.4	R0.15	13	50	6	9,400
KSR-254020R	5.4	R0.2	13	50	6	9,400
KSR-254025R	5.4	R0.25	13	50	6	9,400
KSR-254030R	5.4	R0.3	13	50	6	9,400
KSR-254035R	5.4	R0.35	13	50	6	9,400
KSR-254040R	5.4	R0.4	13	50	6	9,400
KSR-254050R	5.4	R0.5	13	50	6	9,400
KSR-254075R	5.4	R0.75	13	50	6	9,400
KSR-254100R	5.4	R1	13	50	6	9,400
KSR-254125R	5.4	R1.25	13	50	6	9,400
KSR-254150R	5.4	R1.5	13	50	6	9,400
KSR-255010R	5.5	R0.1	13	50	6	9,500
KSR-255015R	5.5	R0.15	13	50	6	9,500
KSR-255020R	5.5	R0.2	13	50	6	9,500
KSR-255025R	5.5	R0.25	13	50	6	9,500
KSR-255030R	5.5	R0.3	13	50	6	9,500
KSR-255035R	5.5	R0.35	13	50	6	9,500
KSR-255040R	5.5	R0.4	13	50	6	9,500
KSR-255050R	5.5	R0.5	13	50	6	9,500
KSR-255075R	5.5	R0.75	13	50	6	9,500
KSR-255100R	5.5	R1	13	50	6	9,500
KSR-255125R	5.5	R1.25	13	50	6	9,500
KSR-255150R	5.5	R1.5	13	50	6	9,500

品番 Code No.	刃径 D Flute Diameter	コーナーR Corner R	刃長 ℓ Flute Length	全長 L Total Length	柄径 d Shank Diameter	標準価格 Retail Price
KSR-256010R	5.6	R0.1	13	50	6	9,500
KSR-256015R	5.6	R0.15	13	50	6	9,500
KSR-256020R	5.6	R0.2	13	50	6	9,500
KSR-256025R	5.6	R0.25	13	50	6	9,500
KSR-256030R	5.6	R0.3	13	50	6	9,500
KSR-256035R	5.6	R0.35	13	50	6	9,500
KSR-256040R	5.6	R0.4	13	50	6	9,500
KSR-256050R	5.6	R0.5	13	50	6	9,500
KSR-256075R	5.6	R0.75	13	50	6	9,500
KSR-256100R	5.6	R1	13	50	6	9,500
KSR-256125R	5.6	R1.25	13	50	6	9,500
KSR-256150R	5.6	R1.5	13	50	6	9,500
KSR-257010R	5.7	R0.1	13	50	6	9,500
KSR-257015R	5.7	R0.15	13	50	6	9,500
KSR-257020R	5.7	R0.2	13	50	6	9,500
KSR-257025R	5.7	R0.25	13	50	6	9,500
KSR-257030R	5.7	R0.3	13	50	6	9,500
KSR-257035R	5.7	R0.35	13	50	6	9,500
KSR-257040R	5.7	R0.4	13	50	6	9,500
KSR-257050R	5.7	R0.5	13	50	6	9,500
KSR-257075R	5.7	R0.75	13	50	6	9,500
KSR-257100R	5.7	R1	13	50	6	9,500
KSR-257125R	5.7	R1.25	13	50	6	9,500
KSR-257150R	5.7	R1.5	13	50	6	9,500
KSR-258010R	5.8	R0.1	13	50	6	9,500
KSR-258015R	5.8	R0.15	13	50	6	9,500
KSR-258020R	5.8	R0.2	13	50	6	9,500
KSR-258025R	5.8	R0.25	13	50	6	9,500
KSR-258030R	5.8	R0.3	13	50	6	9,500
KSR-258035R	5.8	R0.35	13	50	6	9,500
KSR-258040R	5.8	R0.4	13	50	6	9,500
KSR-258050R	5.8	R0.5	13	50	6	9,500
KSR-258075R	5.8	R0.75	13	50	6	9,500
KSR-258100R	5.8	R1	13	50	6	9,500
KSR-258125R	5.8	R1.25	13	50	6	9,500
KSR-258150R	5.8	R1.5	13	50	6	9,500
KSR-259010R	5.9	R0.1	13	50	6	9,500
KSR-259015R	5.9	R0.15	13	50	6	9,500
KSR-259020R	5.9	R0.2	13	50	6	9,500
KSR-259025R	5.9	R0.25	13	50	6	9,500
KSR-259030R	5.9	R0.3	13	50	6	9,500
KSR-259035R	5.9	R0.35	13	50	6	9,500
KSR-259040R	5.9	R0.4	13	50	6	9,500
KSR-259050R	5.9	R0.5	13	50	6	9,500
KSR-259075R	5.9	R0.75	13	50	6	9,500
KSR-259100R	5.9	R1	13	50	6	9,500
KSR-259125R	5.9	R1.25	13	50	6	9,500
KSR-259150R	5.9	R1.5	13	50	6	9,500

超硬製品

Tungsten Carbide





# KSC-2

超硬 2 枚刃コーナーC面付エンドミル  
Tungsten Carbide 2 Flutes Corner C Endmill

- コーナーC面付のエンドミル  
Endmill with corner C
- C面を幅広くラインナップ  
Line-upped various C

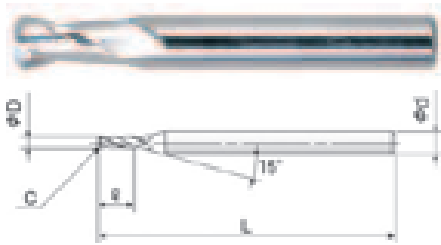

超微粒子合金 Micro Grain Tungsten Carbide



刃径の許容差 Flute Diameter Tolerance  
D 0~-0.01



柄径の許容差 Shank Diameter Tolerance  
d 0~-0.008



ネジレ角30° Twist Angle 30°



コーナーC面の許容差 Tolerance of Corner C  
+0.02~-0.02

- 切削条件表はP217に記載
- Cutting conditions are recommended on page 217.

単位 [寸法 : mm / 価格 : 円]

Unit [size : mm / Retail Price : JPY]

品番 Code No.	刃径 D Flute Diameter	コーナーC Corner C	刃長 ℓ Flute Length	全長 L Total Length	柄径 d Shank Diameter	標準価格 Retail Price
KSC-210010C	1	0.1	3	40	4	6,500
KSC-210015C	1	0.15	3	40	4	6,500
KSC-210020C	1	0.2	3	40	4	6,500
KSC-210025C	1	0.25	3	40	4	6,500
KSC-210030C	1	0.3	4	40	4	6,500
KSC-215010C	1.5	0.1	4	40	4	6,500
KSC-215015C	1.5	0.15	4	40	4	6,500
KSC-215020C	1.5	0.2	4	40	4	6,500
KSC-215025C	1.5	0.25	4	40	4	6,500
KSC-215030C	1.5	0.3	4	40	4	6,500
KSC-220010C	2	0.1	6	40	4	6,500
KSC-220015C	2	0.15	6	40	4	6,500
KSC-220020C	2	0.2	6	40	4	6,500
KSC-220025C	2	0.25	6	40	4	6,500
KSC-220030C	2	0.3	6	40	4	6,500
KSC-220035C	2	0.35	6	40	4	6,500
KSC-220040C	2	0.4	6	40	4	6,500
KSC-220045C	2	0.45	6	40	4	6,500
KSC-220050C	2	0.5	6	40	4	6,500
KSC-225010C	2.5	0.1	8	40	4	7,000
KSC-225015C	2.5	0.15	8	40	4	7,000
KSC-225020C	2.5	0.2	8	40	4	7,000

品番 Code No.	刃径 D Flute Diameter	コーナーC Corner C	刃長 ℓ Flute Length	全長 L Total Length	柄径 d Shank Diameter	標準価格 Retail Price
KSC-225025C	2.5	0.25	8	40	4	7,000
KSC-225030C	2.5	0.3	8	40	4	7,000
KSC-225035C	2.5	0.35	8	40	4	7,000
KSC-225040C	2.5	0.4	8	40	4	7,000
KSC-225045C	2.5	0.45	8	40	4	7,000
KSC-225050C	2.5	0.5	8	40	4	7,000
KSC-230010C	3	0.1	8	45	6	7,800
KSC-230015C	3	0.15	8	45	6	7,800
KSC-230020C	3	0.2	8	45	6	7,800
KSC-230025C	3	0.25	8	45	6	7,800
KSC-230030C	3	0.3	8	45	6	7,800
KSC-230035C	3	0.35	8	45	6	7,800
KSC-230040C	3	0.4	8	45	6	7,800
KSC-230045C	3	0.45	8	45	6	7,800
KSC-230050C	3	0.5	8	45	6	7,800
KSC-230075C	3	0.75	8	45	6	8,500
KSC-230100C	3	1	8	45	6	8,500
KSC-240010C	4	0.1	11	45	6	8,100
KSC-240015C	4	0.15	11	45	6	8,100
KSC-240020C	4	0.2	11	45	6	8,100
KSC-240025C	4	0.25	11	45	6	8,100
KSC-240030C	4	0.3	11	45	6	8,100
KSC-240035C	4	0.35	11	45	6	8,100
KSC-240040C	4	0.4	11	45	6	8,100
KSC-240045C	4	0.45	11	45	6	8,100
KSC-240050C	4	0.5	11	45	6	8,100
KSC-240075C	4	0.75	11	45	6	8,800
KSC-240100C	4	1	11	45	6	8,800
KSC-260010C	6	0.1	13	50	6	8,500
KSC-260015C	6	0.15	13	50	6	8,500
KSC-260020C	6	0.2	13	50	6	8,500
KSC-260025C	6	0.25	13	50	6	8,500
KSC-260030C	6	0.3	13	50	6	8,500
KSC-260035C	6	0.35	13	50	6	8,500
KSC-260040C	6	0.4	13	50	6	8,500
KSC-260045C	6	0.45	13	50	6	8,500
KSC-260050C	6	0.5	13	50	6	8,500
KSC-260075C	6	0.75	13	50	6	9,200
KSC-260100C	6	1	13	50	6	9,200
KSC-260125C	6	1.25	13	50	6	9,200
KSC-260150C	6	1.5	13	50	6	9,200
KSC-260175C	6	1.75	13	50	6	10,100
KSC-260200C	6	2	13	50	6	10,100

# KSV-2

## 超硬センターVエンドミル Tungsten Carbide Center V Endmill

■先端角30° 45° 60° 70° 80° 90° 120° を  
小径サイズ(Φ0.5~Φ6)で揃えました  
line-upped small diameter with edge angle  
30° 45° 60° 70° 80° 90° 120°

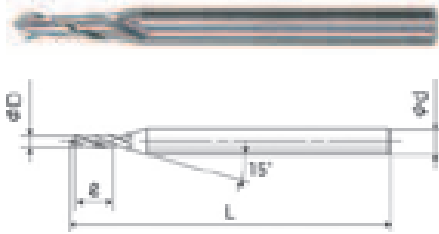

超微粒子合金 Micro Grain Tungsten Carbide



刃径の許容差 Flute Diameter Tolerance  
D 0~-0.01



柄径の許容差 Shank Diameter Tolerance  
d=3 0~-0.006  
3<d≤6 0~-0.008



ネジレ角30° Twist Angle 30°

- 切削条件表はP218に記載
- Cutting conditions are recommended on page 218.

単位[寸法:mm/価格:円]  
Unit [size:mm/Retail Price:JPY]

### KSV-2-90°形



先端角度90° +30°  
-0°

品番 Code No.	刃径 D Flute Diameter	刃長 ℓ Flute Length	全長 L Total Length	柄径 d Shank Diameter	先端フラット径 Edge Flat Diameter	標準価格 Retail Price
KSV-29005	0.5	1	40	3	0.06	8,500
KSV-29006	0.6	1.2	40	3	0.06	8,500
KSV-29007	0.7	1.4	40	3	0.06	7,800
KSV-29008	0.8	1.6	40	3	0.06	7,800
KSV-29009	0.9	2	40	3	0.06	7,500
KSV-29010	1	2	45	4	0.1	7,000
KSV-29011	1.1	2.5	45	4	0.1	7,000
KSV-29012	1.2	2.5	45	4	0.1	7,000
KSV-29013	1.3	3	45	4	0.1	7,000
KSV-29014	1.4	3	45	4	0.1	7,000
KSV-29015	1.5	3	45	4	0.1	7,000
KSV-29016	1.6	3.5	45	4	0.1	7,000
KSV-29017	1.7	3.5	45	4	0.1	7,000
KSV-29018	1.8	4	45	4	0.1	7,000
KSV-29019	1.9	4	45	4	0.1	7,000
KSV-29020	2	4	45	4	0.2	7,000
KSV-29021	2.1	4.5	45	4	0.2	7,800
KSV-29022	2.2	4.5	45	4	0.2	7,800
KSV-29023	2.3	5	45	4	0.2	7,800
KSV-29024	2.4	5	45	4	0.2	7,800

### KSV-2-90°形



先端角度90° +30°  
-0°

品番 Code No.	刃径 D Flute Diameter	刃長 ℓ Flute Length	全長 L Total Length	柄径 d Shank Diameter	先端フラット径 Edge Flat Diameter	標準価格 Retail Price
KSV-29025	2.5	5	45	4	0.2	7,800
KSV-29026	2.6	6	45	4	0.2	7,800
KSV-29027	2.7	6	45	4	0.2	7,800
KSV-29028	2.8	6	45	4	0.2	7,800
KSV-29029	2.9	6	45	4	0.2	7,800
KSV-29030	3	6	45	4	0.2	7,800
KSV-29035	3.5	7	50	6	0.2	10,100
KSV-29040	4	8	50	6	0.2	10,100
KSV-29045	4.5	9	50	6	0.3	11,700
KSV-29050	5	10	60	6	0.3	11,700
KSV-29055	5.5	11	60	6	0.3	12,800
KSV-29060	6	12	60	6	0.3	12,800

### KSV-2-60°形



先端角度60° +30°  
-0°

品番 Code No.	刃径 D Flute Diameter	刃長 ℓ Flute Length	全長 L Total Length	柄径 d Shank Diameter	先端フラット径 Edge Flat Diameter	標準価格 Retail Price
KSV-26005	0.5	1	40	3	0.06	9,400
KSV-26006	0.6	1.2	40	3	0.06	9,400
KSV-26007	0.7	1.4	40	3	0.06	9,400
KSV-26008	0.8	1.6	40	3	0.06	8,500
KSV-26009	0.9	2	40	3	0.06	8,200
KSV-26010	1	2	45	4	0.08	7,800
KSV-26011	1.1	2.5	45	4	0.08	7,800
KSV-26012	1.2	2.5	45	4	0.08	7,800
KSV-26013	1.3	3	45	4	0.08	7,800
KSV-26014	1.4	3	45	4	0.08	7,800
KSV-26015	1.5	3	45	4	0.08	7,800
KSV-26016	1.6	3.5	45	4	0.08	7,800
KSV-26017	1.7	3.5	45	4	0.08	7,800
KSV-26018	1.8	4	45	4	0.08	7,800
KSV-26019	1.9	4	45	4	0.08	7,800
KSV-26020	2	4	45	4	0.1	7,800
KSV-26021	2.1	4.5	45	4	0.1	8,500
KSV-26022	2.2	4.5	45	4	0.1	8,500
KSV-26023	2.3	5	45	4	0.1	8,500
KSV-26024	2.4	5	45	4	0.1	8,500
KSV-26025	2.5	5	45	4	0.1	8,500
KSV-26026	2.6	6	45	4	0.1	8,500
KSV-26027	2.7	6	45	4	0.1	8,500
KSV-26028	2.8	6	45	4	0.1	8,500
KSV-26029	2.9	6	45	4	0.1	8,500
KSV-26030	3	6	45	4	0.1	8,500
KSV-26040	4	8	50	6	0.15	11,200
KSV-26050	5	10	60	6	0.2	12,900
KSV-26060	6	12	60	6	0.2	14,000



# KSVA-2

超硬センターVエンドミル  
Tungsten Carbide 2 Flutes Center V Endmill  
TiAlN Coating

■先端角60° 90° 120°  
edge angle 60° 90° 120°

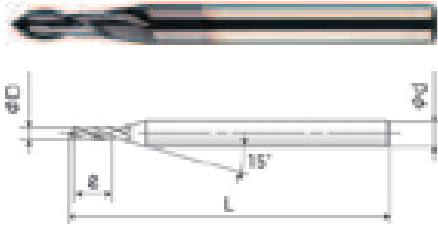

超微粒子合金 Micro Grain Tungsten Carbide



刃径の許容差 Flute Diameter Tolerance  
D 0~-0.01



柄径の許容差 Shank Diameter Tolerance  
d 0~-0.008



ネジレ角30° Twist Angle 30°



先端角度 Edge Angle  
60° 90° 120° +30'  
-0°

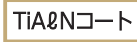

TiAlN コート TiAlN Coating

●切削条件表はP220に記載 単位[寸法:mm/価格:円]  
●Cutting conditions are recommended on page 220. Unit [size:mm/Retail Price:JPY]

品番 Code No.	刃径 D Flute Diameter	先端角 Edge Angle	刃長 ℓ Flute Length	全長 L Total Length	柄径 d Shank Diameter	先端フラット径 Edge Flat Diameter	標準価格 Retail Price
KSVA-209005	0.5	90°	1	40	3	0.06	10,700
KSVA-209006	0.6	90°	1.2	40	3	0.06	10,700
KSVA-209007	0.7	90°	1.4	40	3	0.06	9,900
KSVA-209008	0.8	90°	1.6	40	3	0.06	9,900
KSVA-209009	0.9	90°	2	40	3	0.06	9,600
KSVA-206010	1	60°	2	45	4	0.08	9,300
KSVA-209010	1	90°	2	45	4	0.1	9,300
KSVA-212010	1	120°	2	45	4	0.1	9,300
KSVA-209011	1.1	90°	2.5	45	4	0.1	9,300
KSVA-209012	1.2	90°	2.5	45	4	0.1	9,300
KSVA-209013	1.3	90°	3	45	4	0.1	9,300
KSVA-209014	1.4	90°	3	45	4	0.1	9,300
KSVA-206015	1.5	60°	3	45	4	0.08	9,300
KSVA-209015	1.5	90°	3	45	4	0.1	9,300
KSVA-212015	1.5	120°	3	45	4	0.1	9,300
KSVA-209016	1.6	90°	3.5	45	4	0.1	9,300
KSVA-209017	1.7	90°	3.5	45	4	0.1	9,300
KSVA-209018	1.8	90°	4	45	4	0.1	9,300
KSVA-209019	1.9	90°	4	45	4	0.1	9,300
KSVA-206020	2	60°	4	45	4	0.1	9,300
KSVA-209020	2	90°	4	45	4	0.2	9,300

品番 Code No.	刃径 D Flute Diameter	先端角 Edge Angle	刃長 ℓ Flute Length	全長 L Total Length	柄径 d Shank Diameter	先端フラット径 Edge Flat Diameter	標準価格 Retail Price
KSVA-212020	2	120°	4	45	4	0.2	9,300
KSVA-209021	2.1	90°	4.5	45	4	0.2	9,600
KSVA-209022	2.2	90°	4.5	45	4	0.2	9,600
KSVA-209023	2.3	90°	5	45	4	0.2	9,600
KSVA-209024	2.4	90°	5	45	4	0.2	9,600
KSVA-209025	2.5	90°	5	45	4	0.2	9,600
KSVA-209026	2.6	90°	6	45	4	0.2	9,600
KSVA-209027	2.7	90°	6	45	4	0.2	9,600
KSVA-209028	2.8	90°	6	45	4	0.2	9,600
KSVA-209029	2.9	90°	6	45	4	0.2	9,600
KSVA-206030	3	60°	6	50	6	0.1	10,600
KSVA-209030	3	90°	6	50	6	0.2	10,600
KSVA-212030	3	120°	6	50	6	0.2	10,600
KSVA-209035	3.5	90°	7	50	6	0.2	12,100
KSVA-206040	4	60°	8	50	6	0.15	13,200
KSVA-209040	4	90°	8	50	6	0.2	12,100
KSVA-212040	4	120°	8	50	6	0.2	12,100
KSVA-209045	4.5	90°	9	50	6	0.3	13,800
KSVA-206050	5	60°	10	60	6	0.2	14,900
KSVA-209050	5	90°	10	60	6	0.3	13,800
KSVA-212050	5	120°	10	60	6	0.3	13,800
KSVA-209055	5.5	90°	11	60	6	0.3	14,900
KSVA-206060	6	60°	12	60	6	0.2	16,400
KSVA-209060	6	90°	12	60	6	0.3	14,900
KSVA-212060	6	120°	12	60	6	0.3	14,900

# KSVRA-2

超硬センターVエンドミル (先端R付)  
Tungsten Carbide 2 Flutes Center V Endmill with Edge R  
TiAlN Coating

■先端角60° 90° 120°  
edge angle 60° 90° 120°

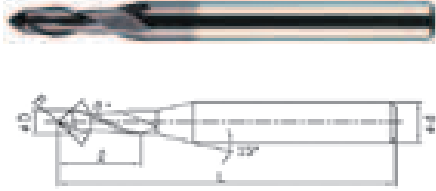

超微粒子合金 Micro Grain Tungsten Carbide



刃径の許容差 Flute Diameter Tolerance  
D 0~-0.01



柄径の許容差 Shank Diameter Tolerance  
d 0~-0.008



ネジレ角30° Twist Angle 30°



先端角度 Edge Angle  
60° 90° 120° +30°  
-0°



TiAlN コート TiAlN Coating

●切削条件表はP222に記載

単位 [寸法 : mm / 価格 : 円]

●Cutting conditions are recommended on page 222.

Unit [size : mm / Retail Price : JPY]

品番 Code No.	刃径 D Flute Diameter	先端角 Edge Angle	先端 R Edge R	刃長 ℓ Flute Length	全長 L Total Length	柄径 d Shank Diameter	標準価格 Retail Price
KSVRA-206010010	1	60°	R0.1	2	50	4	11,400
KSVRA-206010015	1	60°	R0.15	2	50	4	11,400
KSVRA-206010020	1	60°	R0.2	2	50	4	11,400
KSVRA-206010025	1	60°	R0.25	2	50	4	11,400
KSVRA-206010030	1	60°	R0.3	2	50	4	11,400
KSVRA-209010010	1	90°	R0.1	2	50	4	11,400
KSVRA-209010015	1	90°	R0.15	2	50	4	11,400
KSVRA-209010020	1	90°	R0.2	2	50	4	11,400
KSVRA-209010025	1	90°	R0.25	2	50	4	11,400
KSVRA-209010030	1	90°	R0.3	2	50	4	11,400
KSVRA-212010010	1	120°	R0.1	2	50	4	11,400
KSVRA-212010015	1	120°	R0.15	2	50	4	11,400
KSVRA-212010020	1	120°	R0.2	2	50	4	11,400
KSVRA-212010025	1	120°	R0.25	2	50	4	11,400
KSVRA-212010030	1	120°	R0.3	2	50	4	11,400
KSVRA-206015010	1.5	60°	R0.1	3	50	4	11,400
KSVRA-206015015	1.5	60°	R0.15	3	50	4	11,400
KSVRA-206015020	1.5	60°	R0.2	3	50	4	11,400
KSVRA-206015025	1.5	60°	R0.25	3	50	4	11,400
KSVRA-206015030	1.5	60°	R0.3	3	50	4	11,400
KSVRA-209015010	1.5	90°	R0.1	3	50	4	11,400
KSVRA-209015015	1.5	90°	R0.15	3	50	4	11,400

# KSVRA-2

品番 Code No.	刃径 D Flute Diameter	先端角 Edge Angle	先端 R Edge R	刃長 ℓ Flute Length	全長 L Total Length	柄径 d Shank Diameter	標準価格 Retail Price
KSVRA-209015020	1.5	90°	R0.2	3	50	4	11,400
KSVRA-209015025	1.5	90°	R0.25	3	50	4	11,400
KSVRA-209015030	1.5	90°	R0.3	3	50	4	11,400
KSVRA-212015010	1.5	120°	R0.1	3	50	4	11,400
KSVRA-212015015	1.5	120°	R0.15	3	50	4	11,400
KSVRA-212015020	1.5	120°	R0.2	3	50	4	11,400
KSVRA-212015025	1.5	120°	R0.25	3	50	4	11,400
KSVRA-212015030	1.5	120°	R0.3	3	50	4	11,400
KSVRA-206020010	2	60°	R0.1	4	50	4	11,400
KSVRA-206020015	2	60°	R0.15	4	50	4	11,400
KSVRA-206020020	2	60°	R0.2	4	50	4	11,400
KSVRA-206020025	2	60°	R0.25	4	50	4	11,400
KSVRA-206020030	2	60°	R0.3	4	50	4	11,400
KSVRA-206020040	2	60°	R0.4	4	50	4	11,400
KSVRA-206020050	2	60°	R0.5	4	50	4	11,400
KSVRA-209020010	2	90°	R0.1	4	50	4	11,400
KSVRA-209020015	2	90°	R0.15	4	50	4	11,400
KSVRA-209020020	2	90°	R0.2	4	50	4	11,400
KSVRA-209020025	2	90°	R0.25	4	50	4	11,400
KSVRA-209020030	2	90°	R0.3	4	50	4	11,400
KSVRA-209020040	2	90°	R0.4	4	50	4	11,400
KSVRA-209020050	2	90°	R0.5	4	50	4	11,400
KSVRA-212020010	2	120°	R0.1	4	50	4	11,400
KSVRA-212020015	2	120°	R0.15	4	50	4	11,400
KSVRA-212020020	2	120°	R0.2	4	50	4	11,400
KSVRA-212020025	2	120°	R0.25	4	50	4	11,400
KSVRA-212020030	2	120°	R0.3	4	50	4	11,400
KSVRA-212020040	2	120°	R0.4	4	50	4	11,400
KSVRA-212020050	2	120°	R0.5	4	50	4	11,400
KSVRA-206030010	3	60°	R0.1	6	50	6	13,200
KSVRA-206030015	3	60°	R0.15	6	50	6	13,200
KSVRA-206030020	3	60°	R0.2	6	50	6	13,200
KSVRA-206030025	3	60°	R0.25	6	50	6	13,200
KSVRA-206030030	3	60°	R0.3	6	50	6	13,200
KSVRA-206030040	3	60°	R0.4	6	50	6	13,200
KSVRA-206030050	3	60°	R0.5	6	50	6	13,200
KSVRA-206030075	3	60°	R0.75	6	50	6	13,200
KSVRA-206030100	3	60°	R1	6	50	6	13,200
KSVRA-209030010	3	90°	R0.1	6	50	6	13,200
KSVRA-209030015	3	90°	R0.15	6	50	6	13,200
KSVRA-209030020	3	90°	R0.2	6	50	6	13,200
KSVRA-209030025	3	90°	R0.25	6	50	6	13,200
KSVRA-209030030	3	90°	R0.3	6	50	6	13,200
KSVRA-209030040	3	90°	R0.4	6	50	6	13,200
KSVRA-209030050	3	90°	R0.5	6	50	6	13,200
KSVRA-209030075	3	90°	R0.75	6	50	6	13,200
KSVRA-209030100	3	90°	R1	6	50	6	13,200
KSVRA-212030010	3	120°	R0.1	6	50	6	13,200

超硬製品

Tungsten Carbide

# KSVRA-2

品番 Code No.	刃径 D Flute Diameter	先端角 Edge Angle	先端 R Edge R	刃長 ℓ Flute Length	全長 L Total Length	柄径 d Shank Diameter	標準価格 Retail Price
KSVRA-212030015	3	120°	R0.15	6	50	6	13,200
KSVRA-212030020	3	120°	R0.2	6	50	6	13,200
KSVRA-212030025	3	120°	R0.25	6	50	6	13,200
KSVRA-212030030	3	120°	R0.3	6	50	6	13,200
KSVRA-212030040	3	120°	R0.4	6	50	6	13,200
KSVRA-212030050	3	120°	R0.5	6	50	6	13,200
KSVRA-212030075	3	120°	R0.75	6	50	6	13,200
KSVRA-212030100	3	120°	R1	6	50	6	13,200
KSVRA-206060010	6	60°	R0.1	12	60	6	20,200
KSVRA-206060015	6	60°	R0.15	12	60	6	20,200
KSVRA-206060020	6	60°	R0.2	12	60	6	20,200
KSVRA-206060025	6	60°	R0.25	12	60	6	20,200
KSVRA-206060030	6	60°	R0.3	12	60	6	20,200
KSVRA-206060040	6	60°	R0.4	12	60	6	20,200
KSVRA-206060050	6	60°	R0.5	12	60	6	20,200
KSVRA-206060075	6	60°	R0.75	12	60	6	20,200
KSVRA-206060100	6	60°	R1	12	60	6	20,200
KSVRA-206060125	6	60°	R1.25	12	60	6	21,200
KSVRA-206060150	6	60°	R1.5	12	60	6	21,200
KSVRA-206060175	6	60°	R1.75	12	60	6	21,200
KSVRA-206060200	6	60°	R2	12	60	6	21,200
KSVRA-209060010	6	90°	R0.1	12	60	6	18,500
KSVRA-209060015	6	90°	R0.15	12	60	6	18,500
KSVRA-209060020	6	90°	R0.2	12	60	6	18,500
KSVRA-209060025	6	90°	R0.25	12	60	6	18,500
KSVRA-209060030	6	90°	R0.3	12	60	6	18,500
KSVRA-209060040	6	90°	R0.4	12	60	6	18,500
KSVRA-209060050	6	90°	R0.5	12	60	6	18,500
KSVRA-209060075	6	90°	R0.75	12	60	6	18,500
KSVRA-209060100	6	90°	R1	12	60	6	18,500
KSVRA-209060125	6	90°	R1.25	12	60	6	19,600
KSVRA-209060150	6	90°	R1.5	12	60	6	19,600
KSVRA-209060175	6	90°	R1.75	12	60	6	19,600
KSVRA-209060200	6	90°	R2	12	60	6	19,600
KSVRA-212060010	6	120°	R0.1	12	60	6	18,500
KSVRA-212060015	6	120°	R0.15	12	60	6	18,500
KSVRA-212060020	6	120°	R0.2	12	60	6	18,500
KSVRA-212060025	6	120°	R0.25	12	60	6	18,500
KSVRA-212060030	6	120°	R0.3	12	60	6	18,500
KSVRA-212060040	6	120°	R0.4	12	60	6	18,500
KSVRA-212060050	6	120°	R0.5	12	60	6	18,500
KSVRA-212060075	6	120°	R0.75	12	60	6	18,500
KSVRA-212060100	6	120°	R1	12	60	6	18,500
KSVRA-212060125	6	120°	R1.25	12	60	6	19,600
KSVRA-212060150	6	120°	R1.5	12	60	6	19,600
KSVRA-212060175	6	120°	R1.75	12	60	6	19,600
KSVRA-212060200	6	120°	R2	12	60	6	19,600

# KMC-2

## 超硬面取りカッター Tungsten Carbide Chamfering Cutter

■精密加工部品の面取りや深彫りの面取り加工に  
小径サイズを取り揃えました  
Released for chamfering of precise parts and deep  
cutting by small diameter

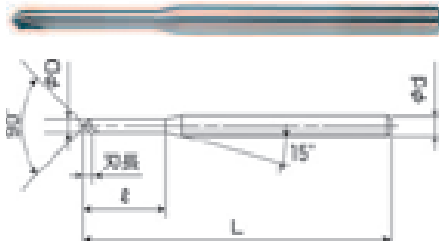

超微粒子合金 Micro Grain Tungsten Carbide



刃径の許容差 Flute Diameter Tolerance  
D 0~-0.01



柄径の許容差 Shank Diameter Tolerance  
d 0~-0.008



ネジレ角0° Twist Angle 0°  
(直刃2枚刃) (Straight 2 Flutes)



先端角度90° +15'  
Edge Angle 90° -15'

●切削条件表はP224に記載 単位[寸法:mm/価格:円]  
●Cutting conditions are recommended on page 224. Unit [size:mm/Retail Price:JPY]

品番 Code No.	刃径 D Flute Diameter	有効長 ℓ Effective Length	全長 L Total Length	柄径 d Shank Diameter	先端フット径 Edgeflat Diameter	標準価格 Retail Price
KMC-29003S	0.3	1	40	4	0.03	5,700
KMC-29003L	0.3	3	40	4	0.06	6,400
KMC-29003060	0.3	6	40	4	0.06	7,500
KMC-29004S	0.4	1	40	4	0.03	5,700
KMC-29004L	0.4	3	40	4	0.06	6,400
KMC-29004060	0.4	6	40	4	0.06	7,500
KMC-29005S	0.5	1.5	40	4	0.04	4,900
KMC-29005L	0.5	5	40	4	0.08	6,000
KMC-29005075	0.5	7.5	40	4	0.08	7,000
KMC-29005100	0.5	10	40	4	0.08	7,500
KMC-29006S	0.6	1.5	40	4	0.04	4,900
KMC-29006L	0.6	5	40	4	0.08	6,000
KMC-29006100	0.6	10	40	4	0.08	7,500
KMC-29007S	0.7	2	40	4	0.04	4,600
KMC-29007L	0.7	6	40	4	0.08	5,700
KMC-29007100	0.7	10	40	4	0.08	6,700
KMC-29008S	0.8	2	40	4	0.04	4,600
KMC-29008L	0.8	6	40	4	0.08	5,700
KMC-29008100	0.8	10	40	4	0.08	6,700
KMC-29008150	0.8	15	50	4	0.08	7,000
KMC-29009S	0.9	3	40	4	0.04	4,600
KMC-29009L	0.9	8	40	4	0.08	5,700
KMC-29009150	0.9	15	50	4	0.08	7,000

品番 Code No.	刃径 D Flute Diameter	有効長 ℓ Effective Length	全長 L Total Length	柄径 d Shank Diameter	先端フット径 Edgeflat Diameter	標準価格 Retail Price
KMC-29010S	1	3	45	4	0.06	4,300
KMC-29010L	1	8	60	4	0.1	5,300
KMC-29010100	1	10	60	4	0.1	5,300
KMC-29010150	1	15	60	4	0.1	5,500
KMC-29010200	1	20	60	4	0.1	6,000
KMC-29010250	1	25	70	4	0.1	6,500
KMC-29010300	1	30	70	4	0.1	7,000
KMC-29012S	1.2	4	45	4	0.1	4,300
KMC-29012L	1.2	10	60	4	0.1	5,300
KMC-29012150	1.2	15	60	4	0.1	5,500
KMC-29012200	1.2	20	60	4	0.1	6,000
KMC-29012250	1.2	25	70	4	0.1	6,500
KMC-29012300	1.2	30	70	4	0.1	7,000
KMC-29015S	1.5	4	45	4	0.06	4,300
KMC-29015L	1.5	10	60	4	0.1	5,300
KMC-29015150	1.5	15	60	4	0.1	5,500
KMC-29015200	1.5	20	60	4	0.1	6,000
KMC-29015250	1.5	25	70	4	0.1	6,500
KMC-29015300	1.5	30	70	4	0.1	7,000
KMC-29015350	1.5	35	80	4	0.15	7,700
KMC-29015400	1.5	40	80	4	0.15	8,000
KMC-29018S	1.8	5	45	4	0.06	4,300
KMC-29018100	1.8	10	45	4	0.06	4,500
KMC-29018L	1.8	15	60	4	0.1	5,300
KMC-29018200	1.8	20	60	4	0.1	6,000
KMC-29018250	1.8	25	70	4	0.1	6,500
KMC-29018300	1.8	30	70	4	0.1	7,000
KMC-29020S	2	5	45	4	0.1	4,300
KMC-29020100	2	10	45	4	0.1	4,500
KMC-29020L	2	15	60	4	0.2	5,300
KMC-29020200	2	20	60	4	0.2	6,000
KMC-29020250	2	25	70	4	0.2	6,500
KMC-29020300	2	30	70	4	0.2	7,000
KMC-29020350	2	35	80	4	0.2	7,700
KMC-29020400	2	40	80	4	0.2	8,000
KMC-29020500	2	50	100	4	0.2	9,400
KMC-29025S	2.5	6	45	4	0.1	4,900
KMC-29025L	2.5	20	60	4	0.2	6,000
KMC-29025300	2.5	30	70	4	0.2	7,400
KMC-29025400	2.5	40	80	4	0.2	8,400
KMC-29025500	2.5	50	100	4	0.2	9,500
KMC-29030S	3	6	45	4	0.1	4,900
KMC-29030L	3	20	60	4	0.2	6,000
KMC-29030300	3	30	70	4	0.2	7,400
KMC-29030400	3	40	80	4	0.2	8,400
KMC-29030500	3	50	100	4	0.2	9,500
KMC-29040070	4	—	70	4	0.2	5,700
KMC-29040120	4	—	120	4	0.2	8,000

超硬製品

Tungsten Carbide



# KUMC-4

## 超硬裏面取りカッター

Tungsten Carbide Chamfering Cutter Single Angular type

- 直刃4枚刃 Straight 4 flutes
- 45° (片角タイプ) (Single Angular type)

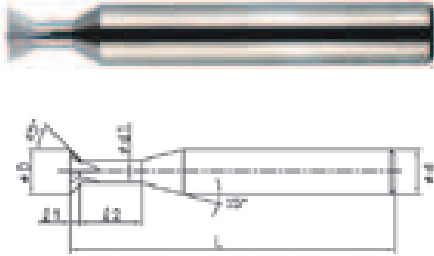

超微粒子合金 Micro Grain Tungsten Carbide



刃径の許容差 Flute Diameter Tolerance  
D 0~-0.05



柄径の許容差 Shank Diameter Tolerance  
d=4, 6 0~-0.008  
d=8, 10 0~-0.009



ネジレ角0° Twist Angle 0°  
(直刃4枚刃) (4 Flutes Straight Endmill)  
面取角度45° (片角) ±10° Chamfer Angle Tolerance

●切削条件表はP226に記載 単位[寸法:mm/価格:円]  
●Cutting conditions are recommended on page 226. Unit [size:mm/Retail Price:JPY]

品番 Code No.	外径 D Flute Diameter	有効長 L2 Effective Length	刃長 L1 Flute Length	首径 d1 Neck Diameter	全長 L Total Length	柄径 d Shank Diameter	標準価格 Retail Price
KUMC-445015S	1.5	4	0.2	1	50	4	11,400
KUMC-445015L	1.5	8	0.2	1	50	4	12,500
KUMC-445016S	1.6	4	0.25	1	50	4	11,400
KUMC-445016L	1.6	8	0.25	1	50	4	12,500
KUMC-445017S	1.7	4	0.3	1	50	4	11,400
KUMC-445017L	1.7	8	0.3	1	50	4	12,500
KUMC-445018S	1.8	4	0.3	1.1	50	4	11,400
KUMC-445018L	1.8	8	0.3	1.1	50	4	12,500
KUMC-445019S	1.9	4	0.3	1.2	50	4	11,400
KUMC-445019L	1.9	8	0.3	1.2	50	4	12,500
KUMC-445020S	2	5	0.4	1.1	50	4	11,400
KUMC-445020L	2	10	0.4	1.1	50	4	12,500
KUMC-445021S	2.1	5	0.4	1.2	50	4	11,400
KUMC-445021L	2.1	10	0.4	1.2	50	4	12,500
KUMC-445022S	2.2	5	0.4	1.3	50	4	11,400
KUMC-445022L	2.2	10	0.4	1.3	50	4	12,500
KUMC-445023S	2.3	5	0.4	1.4	50	4	11,400
KUMC-445023L	2.3	10	0.4	1.4	50	4	12,500
KUMC-445024S	2.4	5	0.4	1.5	50	4	11,400
KUMC-445024L	2.4	10	0.4	1.5	50	4	12,500
KUMC-445025S	2.5	6	0.5	1.4	50	4	11,400
KUMC-445025L	2.5	12	0.5	1.4	50	4	12,500
KUMC-445026S	2.6	6	0.5	1.5	50	4	11,400
KUMC-445026L	2.6	12	0.5	1.5	50	4	12,500

品番 Code No.	外径 D Flute Diameter	有効長 L2 Effective Length	刃長 L1 Flute Length	首径 d1 Neck Diameter	全長 L Total Length	柄径 d Shank Diameter	標準価格 Retail Price
KUMC-445027S	2.7	6	0.5	1.6	50	4	11,400
KUMC-445027L	2.7	12	0.5	1.6	50	4	12,500
KUMC-445028S	2.8	6	0.5	1.7	50	4	11,400
KUMC-445028L	2.8	12	0.5	1.7	50	4	12,500
KUMC-445029S	2.9	6	0.5	1.8	50	4	11,400
KUMC-445029L	2.9	12	0.5	1.8	50	4	12,500
KUMC-445030S	3	8	0.6	1.7	50	4	12,500
KUMC-445030L	3	16	0.6	1.7	50	4	13,500
KUMC-445031S	3.1	8	0.6	1.8	50	4	12,500
KUMC-445031L	3.1	16	0.6	1.8	50	4	13,500
KUMC-445032S	3.2	8	0.6	1.9	50	4	12,500
KUMC-445032L	3.2	16	0.6	1.9	50	4	13,500
KUMC-445033S	3.3	8	0.6	2	50	4	12,500
KUMC-445033L	3.3	16	0.6	2	50	4	13,500
KUMC-445034S	3.4	8	0.6	2.1	50	4	12,500
KUMC-445034L	3.4	16	0.6	2.1	50	4	13,500
KUMC-445035S	3.5	9	0.7	2	50	4	12,500
KUMC-445035L	3.5	18	0.7	2	50	4	13,500
KUMC-445036S	3.6	9	0.7	2.1	50	4	12,500
KUMC-445036L	3.6	18	0.7	2.1	50	4	13,500
KUMC-445037S	3.7	9	0.7	2.2	50	4	12,500
KUMC-445037L	3.7	18	0.7	2.2	50	4	13,500
KUMC-445038S	3.8	9	0.7	2.3	50	4	12,500
KUMC-445038L	3.8	18	0.7	2.3	50	4	13,500
KUMC-445039S	3.9	9	0.7	2.4	50	4	12,500
KUMC-445039L	3.9	18	0.7	2.4	50	4	13,500
KUMC-445040S	4	10	0.8	2.3	50	4	12,500
KUMC-445040L	4	20	0.8	2.3	60	4	13,500
KUMC-445041S	4.1	10	0.8	2.4	50	6	13,500
KUMC-445041L	4.1	20	0.8	2.4	60	6	14,900
KUMC-445042S	4.2	10	0.8	2.5	50	6	13,500
KUMC-445042L	4.2	20	0.8	2.5	60	6	14,900
KUMC-445043S	4.3	10	0.8	2.6	50	6	13,500
KUMC-445043L	4.3	20	0.8	2.6	60	6	14,900
KUMC-445044S	4.4	10	0.8	2.7	50	6	13,500
KUMC-445044L	4.4	20	0.8	2.7	60	6	14,900
KUMC-445045S	4.5	12	1	2.4	50	6	13,500
KUMC-445045L	4.5	24	1	2.4	60	6	14,900
KUMC-445046S	4.6	12	1	2.5	50	6	13,500
KUMC-445046L	4.6	24	1	2.5	60	6	14,900
KUMC-445047S	4.7	12	1	2.6	50	6	13,500
KUMC-445047L	4.7	24	1	2.6	60	6	14,900
KUMC-445048S	4.8	12	1	2.7	50	6	13,500
KUMC-445048L	4.8	24	1	2.7	60	6	14,900
KUMC-445049S	4.9	12	1	2.8	50	6	13,500
KUMC-445049L	4.9	24	1	2.8	60	6	14,900
KUMC-445050S	5	12	1.1	2.7	50	6	13,500
KUMC-445050L	5	24	1.1	2.7	60	6	14,900



# KUMW-4

## 超硬裏面取りカッター

Tungsten Carbide Chamfering Cutter W Angular type

- 直刃4枚刃 Straight 4 flutes
- 90° (両角タイプ) (Double Angular type)



超微粒子合金 Micro Grain Tungsten Carbide



刃径の許容差 Flute Diameter Tolerance  
D 0~-0.05



柄径の許容差 Shank Diameter Tolerance  
d=4, 6 0~-0.008  
d=8, 10 0~-0.009



ネジレ角0° Twist Angle 0°  
(直刃4枚刃) (Straight 4 Flutes)  
面取角度90° (両角) ±15' Chamfer Angle Tolerances

- 切削条件表はP226に記載 単位[寸法:mm/価格:円]
- Cutting conditions are recommended on page 226. Unit [size:mm/Retail Price:JPY]

品番 Code No.	外径 D Flute Diameter	有効長 ℓ2 Effective Length	刃長 ℓ1 Flute Length	首径 d1 Neck Diameter	全長 L Total Length	柄径 d Shank Diameter	標準価格 Retail Price
KUMW-490015S	1.5	4	0.4	1	50	4	11,400
KUMW-490015L	1.5	8	0.4	1	50	4	12,500
KUMW-490016S	1.6	4	0.5	1	50	4	11,400
KUMW-490016L	1.6	8	0.5	1	50	4	12,500
KUMW-490017S	1.7	4	0.6	1	50	4	11,400
KUMW-490017L	1.7	8	0.6	1	50	4	12,500
KUMW-490018S	1.8	4	0.6	1.1	50	4	11,400
KUMW-490018L	1.8	8	0.6	1.1	50	4	12,500
KUMW-490019S	1.9	4	0.6	1.2	50	4	11,400
KUMW-490019L	1.9	8	0.6	1.2	50	4	12,500
KUMW-490020S	2	5	0.8	1.1	50	4	11,400
KUMW-490020L	2	10	0.8	1.1	50	4	12,500
KUMW-490021S	2.1	5	0.8	1.2	50	4	11,400
KUMW-490021L	2.1	10	0.8	1.2	50	4	12,500
KUMW-490022S	2.2	5	0.8	1.3	50	4	11,400
KUMW-490022L	2.2	10	0.8	1.3	50	4	12,500
KUMW-490023S	2.3	5	0.8	1.4	50	4	11,400
KUMW-490023L	2.3	10	0.8	1.4	50	4	12,500
KUMW-490024S	2.4	5	0.8	1.5	50	4	11,400
KUMW-490024L	2.4	10	0.8	1.5	50	4	12,500
KUMW-490025S	2.5	6	1	1.4	50	4	11,400
KUMW-490025L	2.5	12	1	1.4	50	4	12,500
KUMW-490026S	2.6	6	1	1.5	50	4	11,400
KUMW-490026L	2.6	12	1	1.5	50	4	12,500

品番 Code No.	外径 D Flute Diameter	有効長 ℓ2 Effective Length	刃長 ℓ1 Flute Length	首径 d1 Neck Diameter	全長 L Total Length	柄径 d Shank Diameter	標準価格 Retail Price
KUMW-490027S	2.7	6	1	1.6	50	4	11,400
KUMW-490027L	2.7	12	1	1.6	50	4	12,500
KUMW-490028S	2.8	6	1	1.7	50	4	11,400
KUMW-490028L	2.8	12	1	1.7	50	4	12,500
KUMW-490029S	2.9	6	1	1.8	50	4	11,400
KUMW-490029L	2.9	12	1	1.8	50	4	12,500
KUMW-490030S	3	8	1.2	1.7	50	4	12,500
KUMW-490030L	3	16	1.2	1.7	50	4	13,500
KUMW-490031S	3.1	8	1.2	1.8	50	4	12,500
KUMW-490031L	3.1	16	1.2	1.8	50	4	13,500
KUMW-490032S	3.2	8	1.2	1.9	50	4	12,500
KUMW-490032L	3.2	16	1.2	1.9	50	4	13,500
KUMW-490033S	3.3	8	1.2	2	50	4	12,500
KUMW-490033L	3.3	16	1.2	2	50	4	13,500
KUMW-490034S	3.4	8	1.2	2.1	50	4	12,500
KUMW-490034L	3.4	16	1.2	2.1	50	4	13,500
KUMW-490035S	3.5	9	1.4	2	50	4	12,500
KUMW-490035L	3.5	18	1.4	2	50	4	13,500
KUMW-490036S	3.6	9	1.4	2.1	50	4	12,500
KUMW-490036L	3.6	18	1.4	2.1	50	4	13,500
KUMW-490037S	3.7	9	1.4	2.2	50	4	12,500
KUMW-490037L	3.7	18	1.4	2.2	50	4	13,500
KUMW-490038S	3.8	9	1.4	2.3	50	4	12,500
KUMW-490038L	3.8	18	1.4	2.3	50	4	13,500
KUMW-490039S	3.9	9	1.4	2.4	50	4	12,500
KUMW-490039L	3.9	18	1.4	2.4	50	4	13,500
KUMW-490040S	4	10	1.6	2.3	50	4	12,500
KUMW-490040L	4	20	1.6	2.3	60	4	13,500
KUMW-490041S	4.1	10	1.6	2.4	50	6	13,500
KUMW-490041L	4.1	20	1.6	2.4	60	6	14,900
KUMW-490042S	4.2	10	1.6	2.5	50	6	13,500
KUMW-490042L	4.2	20	1.6	2.5	60	6	14,900
KUMW-490043S	4.3	10	1.6	2.6	50	6	13,500
KUMW-490043L	4.3	20	1.6	2.6	60	6	14,900
KUMW-490044S	4.4	10	1.6	2.7	50	6	13,500
KUMW-4900445L	4.4	20	1.6	2.7	60	6	14,900
KUMW-490045S	4.5	12	2	2.4	50	6	13,500
KUMW-490045L	4.5	24	2	2.4	60	6	14,900
KUMW-490046S	4.6	12	2	2.5	50	6	13,500
KUMW-490046L	4.6	24	2	2.5	60	6	14,900
KUMW-490047S	4.7	12	2	2.6	50	6	13,500
KUMW-490047L	4.7	24	2	2.6	60	6	14,900
KUMW-490048S	4.8	12	2	2.7	50	6	13,500
KUMW-490048L	4.8	24	2	2.7	60	6	14,900
KUMW-490049S	4.9	12	2	2.8	50	6	13,500
KUMW-490049L	4.9	24	2	2.8	60	6	14,900
KUMW-490050S	5	12	2.2	2.7	50	6	13,500
KUMW-490050L	5	24	2.2	2.7	60	6	14,900



# KHR-4

## 超硬底刃付リーマ

Tungsten Carbide Reamer with Bottom Flute

■底刃が付いているので止まり穴の加工などに最適です  
Best for stop hole processing due to having bottom flute

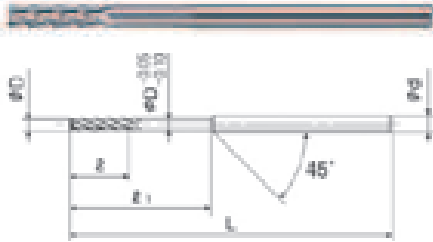

微粒子合金 (K10) Regular Grain Carbide



刃径の許容差 Flute Diameter Tolerance

$D \leq 3.09$   $+0.005 \sim 0$   
 $3.1 < D \leq 12.03$   $+0.007 \sim 0$



柄径の許容差 Shank Diameter Tolerance

$d = 3$   $0 \sim -0.006$   
 $3 < d \leq 6.05$   $0 \sim -0.008$   
 $8 < d \leq 10$   $0 \sim -0.009$   
 $d = 12$   $0 \sim -0.011$



ネジレ角 右ネジレ35° Twist Angle 35°



喰付寸法 (K=喰付角片角45°)

Chamfer Size (K=Chamfer Angle Single 45°)

$C = 0.1 \pm 0.03$   $\phi 0.5 \sim \phi 1.99$   
 $C = 0.15 \pm 0.03$   $\phi 2 \sim \phi 3.09$   
 $C = 0.2 \pm 0.03$   $\phi 3.1 \sim \phi 7.05$   
 $C = 0.3 \pm 0.03$   $\phi 7.1 \sim \phi 10.05$   
 $C = 0.4 \pm 0.03$   $\phi 10.1 \sim \phi 12.03$

●切削条件表はP227に記載

単位 [寸法: mm / 価格: 円]

●Cutting conditions are recommended on page 227.

Unit [size: mm / Retail Price: JPY]

品番 Code No.	刃径 D Flute Diameter	刃長 ℓ Flute Length	有効長 ℓ1 Effective Length	全長 L Total Length	柄径 d Shank Diameter	標準価格 Retail Price
KHR-4050	0.5	4	10	50	3	10,200
KHR-4051	0.51	4	10	50	3	11,100
KHR-4052	0.52	4	10	50	3	11,100
KHR-4053	0.53	4	10	50	3	11,100
KHR-4054	0.54	4	10	50	3	11,100
KHR-4055	0.55	4	10	50	3	11,100
KHR-4056	0.56	4	10	50	3	11,100
KHR-4057	0.57	4	10	50	3	11,100
KHR-4058	0.58	4	10	50	3	11,100
KHR-4059	0.59	4	10	50	3	11,100
KHR-4060	0.6	4	10	50	3	10,200
KHR-4061	0.61	4	10	50	3	11,100
KHR-4062	0.62	4	10	50	3	11,100
KHR-4063	0.63	4	10	50	3	11,100
KHR-4064	0.64	4	10	50	3	11,100
KHR-4065	0.65	4	10	50	3	11,100
KHR-4066	0.66	4	10	50	3	11,100
KHR-4067	0.67	4	10	50	3	11,100
KHR-4068	0.68	4	10	50	3	11,100
KHR-4069	0.69	4	10	50	3	11,100
KHR-4070	0.7	4	10	50	3	10,200
KHR-4071	0.71	4	10	50	3	11,100

品番 Code No.	刃径 D Flute Diameter	刃長 ℓ Flute Length	有効長 ℓ1 Effective Length	全長 L Total Length	柄径 d Shank Diameter	標準価格 Retail Price
KHR-4072	0.72	4	10	50	3	11,100
KHR-4073	0.73	4	10	50	3	11,100
KHR-4074	0.74	4	10	50	3	11,100
KHR-4075	0.75	4	10	50	3	11,100
KHR-4076	0.76	4	10	50	3	11,100
KHR-4077	0.77	4	10	50	3	11,100
KHR-4078	0.78	4	10	50	3	11,100
KHR-4079	0.79	5	12	50	3	11,100
KHR-4080	0.8	5	12	50	3	9,900
KHR-4081	0.81	5	12	50	3	10,600
KHR-4082	0.82	5	12	50	3	10,600
KHR-4083	0.83	5	12	50	3	10,600
KHR-4084	0.84	5	12	50	3	10,600
KHR-4085	0.85	5	12	50	3	10,600
KHR-4086	0.86	5	12	50	3	10,600
KHR-4087	0.87	5	12	50	3	10,600
KHR-4088	0.88	5	12	50	3	10,600
KHR-4089	0.89	5	12	50	3	10,600
KHR-4090	0.9	5	12	50	3	9,900
KHR-4091	0.91	5	12	50	3	10,600
KHR-4092	0.92	5	12	50	3	10,600
KHR-4093	0.93	5	12	50	3	10,600
KHR-4094	0.94	5	12	50	3	10,600
KHR-4095	0.95	5	12	50	3	10,600
KHR-4096	0.96	5	12	50	3	10,600
KHR-4097	0.97	5	12	50	3	10,600
KHR-4098	0.98	5	12	50	3	10,600
KHR-4099	0.99	5	12	50	3	10,600
KHR-4100	1	6	15	60	3	9,900
KHR-4101	1.01	6	15	60	3	10,600
KHR-4102	1.02	6	15	60	3	10,600
KHR-4103	1.03	6	15	60	3	10,600
KHR-4104	1.04	6	15	60	3	10,600
KHR-4105	1.05	6	15	60	3	10,600
KHR-4106	1.06	6	15	60	3	10,600
KHR-4107	1.07	6	15	60	3	10,600
KHR-4108	1.08	6	15	60	3	10,600
KHR-4109	1.09	6	15	60	3	10,600
KHR-4110	1.1	6	15	60	3	9,900
KHR-4111	1.11	6	15	60	3	10,600
KHR-4112	1.12	6	15	60	3	10,600
KHR-4113	1.13	6	15	60	3	10,600
KHR-4114	1.14	6	15	60	3	10,600
KHR-4115	1.15	6	15	60	3	10,600
KHR-4116	1.16	6	15	60	3	10,600
KHR-4117	1.17	6	15	60	3	10,600
KHR-4118	1.18	6	15	60	3	10,600
KHR-4119	1.19	6	15	60	3	10,600

# KHR-4

品番 Code No.	刃径 D Flute Diameter	刃長 ℓ Flute Length	有効長ℓ1 Effective Length	全長 L Total Length	柄径 d Shank Diameter	標準価格 Retail Price
KHR-4120	1.2	6	15	60	3	9,900
KHR-4121	1.21	6	15	60	3	10,600
KHR-4122	1.22	6	15	60	3	10,600
KHR-4123	1.23	6	15	60	3	10,600
KHR-4124	1.24	6	15	60	3	10,600
KHR-4125	1.25	6	15	60	3	10,600
KHR-4126	1.26	6	15	60	3	10,600
KHR-4127	1.27	6	15	60	3	10,600
KHR-4128	1.28	6	15	60	3	10,600
KHR-4129	1.29	6	15	60	3	10,600
KHR-4130	1.3	6	15	60	3	9,900
KHR-4131	1.31	6	15	60	3	10,600
KHR-4132	1.32	6	15	60	3	10,600
KHR-4133	1.33	6	15	60	3	10,600
KHR-4134	1.34	6	15	60	3	10,600
KHR-4135	1.35	6	15	60	3	10,600
KHR-4136	1.36	6	15	60	3	10,600
KHR-4137	1.37	6	15	60	3	10,600
KHR-4138	1.38	6	15	60	3	10,600
KHR-4139	1.39	6	15	60	3	10,600
KHR-4140	1.4	6	15	60	3	9,900
KHR-4141	1.41	6	15	60	3	10,600
KHR-4142	1.42	6	15	60	3	10,600
KHR-4143	1.43	6	15	60	3	10,600
KHR-4144	1.44	6	15	60	3	10,600
KHR-4145	1.45	6	15	60	3	10,600
KHR-4146	1.46	6	15	60	3	10,600
KHR-4147	1.47	6	15	60	3	10,600
KHR-4148	1.48	6	15	60	3	10,600
KHR-4149	1.49	6	15	60	3	10,600
KHR-4150	1.5	8	20	60	3	9,900
KHR-4151	1.51	8	20	60	3	10,600
KHR-4152	1.52	8	20	60	3	10,600
KHR-4153	1.53	8	20	60	3	10,600
KHR-4154	1.54	8	20	60	3	10,600
KHR-4155	1.55	8	20	60	3	10,600
KHR-4156	1.56	8	20	60	3	10,600
KHR-4157	1.57	8	20	60	3	10,600
KHR-4158	1.58	8	20	60	3	10,600
KHR-4159	1.59	8	20	60	3	10,600
KHR-4160	1.6	8	20	60	3	9,900
KHR-4161	1.61	8	20	60	3	10,600
KHR-4162	1.62	8	20	60	3	10,600
KHR-4163	1.63	8	20	60	3	10,600
KHR-4164	1.64	8	20	60	3	10,600
KHR-4165	1.65	8	20	60	3	10,600
KHR-4166	1.66	8	20	60	3	10,600
KHR-4167	1.67	8	20	60	3	10,600

品番 Code No.	刃径 D Flute Diameter	刃長 ℓ Flute Length	有効長ℓ1 Effective Length	全長 L Total Length	柄径 d Shank Diameter	標準価格 Retail Price
KHR-4168	1.68	8	20	60	3	10,600
KHR-4169	1.69	8	20	60	3	10,600
KHR-4170	1.7	8	20	60	3	9,900
KHR-4171	1.71	8	20	60	3	10,600
KHR-4172	1.72	8	20	60	3	10,600
KHR-4173	1.73	8	20	60	3	10,600
KHR-4174	1.74	8	20	60	3	10,600
KHR-4175	1.75	8	20	60	3	10,600
KHR-4176	1.76	8	20	60	3	10,600
KHR-4177	1.77	8	20	60	3	10,600
KHR-4178	1.78	8	20	60	3	10,600
KHR-4179	1.79	8	20	60	3	10,600
KHR-4180	1.8	8	20	60	3	9,900
KHR-4181	1.81	8	20	60	3	10,600
KHR-4182	1.82	8	20	60	3	10,600
KHR-4183	1.83	8	20	60	3	10,600
KHR-4184	1.84	8	20	60	3	10,600
KHR-4185	1.85	8	20	60	3	10,600
KHR-4186	1.86	8	20	60	3	10,600
KHR-4187	1.87	8	20	60	3	10,600
KHR-4188	1.88	8	20	60	3	10,600
KHR-4189	1.89	8	20	60	3	10,600
KHR-4190	1.9	8	20	60	3	9,900
KHR-4191	1.91	10	24	60	3	10,600
KHR-4192	1.92	10	24	60	3	10,600
KHR-4193	1.93	10	24	60	3	10,600
KHR-4194	1.94	10	24	60	3	10,600
KHR-4195	1.95	10	24	60	3	10,600
KHR-4196	1.96	10	24	60	3	10,600
KHR-4197	1.97	10	24	60	3	10,600
KHR-4198	1.98	10	24	60	3	10,600
KHR-4199	1.99	10	24	60	3	10,600
KHR-4200	2	10	24	60	3	9,900
KHR-4201	2.01	10	24	60	3	10,600
KHR-4202	2.02	10	24	60	3	10,600
KHR-4203	2.03	10	24	60	3	10,600
KHR-4204	2.04	10	24	60	3	10,600
KHR-4205	2.05	10	24	60	3	10,600
KHR-4206	2.06	10	24	60	3	10,600
KHR-4207	2.07	10	24	60	3	10,600
KHR-4208	2.08	10	24	60	3	10,600
KHR-4209	2.09	10	24	60	3	10,600
KHR-4210	2.1	10	24	60	3	9,900
KHR-4211	2.11	10	24	60	3	10,600
KHR-4212	2.12	10	24	60	3	10,600
KHR-4213	2.13	10	24	60	3	10,600
KHR-4214	2.14	10	24	60	3	10,600
KHR-4215	2.15	10	24	60	3	10,600

超硬製品

Tungsten Carbide

# KHR-4

品番 Code No.	刃径 D Flute Diameter	刃長 ℓ Flute Length	有効長ℓ1 Effective Length	全長 L Total Length	柄径 d Shank Diameter	標準価格 Retail Price
KHR-4216	2.16	10	24	60	3	10,600
KHR-4217	2.17	10	24	60	3	10,600
KHR-4218	2.18	10	24	60	3	10,600
KHR-4219	2.19	10	24	60	3	10,600
KHR-4220	2.2	10	24	60	3	9,900
KHR-4221	2.21	10	24	60	3	10,600
KHR-4222	2.22	10	24	60	3	10,600
KHR-4223	2.23	10	24	60	3	10,600
KHR-4224	2.24	10	24	60	3	10,600
KHR-4225	2.25	10	24	60	3	10,600
KHR-4226	2.26	10	24	60	3	10,600
KHR-4227	2.27	10	24	60	3	10,600
KHR-4228	2.28	10	24	60	3	10,600
KHR-4229	2.29	10	24	60	3	10,600
KHR-4230	2.3	10	24	60	3	9,900
KHR-4231	2.31	10	24	60	3	10,600
KHR-4232	2.32	10	24	60	3	10,600
KHR-4233	2.33	10	24	60	3	10,600
KHR-4234	2.34	10	24	60	3	10,600
KHR-4235	2.35	10	24	60	3	10,600
KHR-4236	2.36	10	24	60	3	10,600
KHR-4237	2.37	10	24	60	3	10,600
KHR-4238	2.38	10	24	60	3	10,600
KHR-4239	2.39	10	24	60	3	10,600
KHR-4240	2.4	10	24	60	3	9,900
KHR-4241	2.41	10	24	60	3	10,600
KHR-4242	2.42	10	24	60	3	10,600
KHR-4243	2.43	10	24	60	3	10,600
KHR-4244	2.44	10	24	60	3	10,600
KHR-4245	2.45	10	24	60	3	10,600
KHR-4246	2.46	10	24	60	3	10,600
KHR-4247	2.47	10	24	60	3	10,600
KHR-4248	2.48	10	24	60	3	10,600
KHR-4249	2.49	10	24	60	3	10,600
KHR-4250	2.5	10	24	60	3	9,900
KHR-4251	2.51	10	24	60	3	10,600
KHR-4252	2.52	10	24	60	3	10,600
KHR-4253	2.53	10	24	60	3	10,600
KHR-4254	2.54	10	24	60	3	10,600
KHR-4255	2.55	10	24	60	3	10,600
KHR-4256	2.56	10	24	60	3	10,600
KHR-4257	2.57	10	24	60	3	10,600
KHR-4258	2.58	10	24	60	3	10,600
KHR-4259	2.59	10	24	60	3	10,600
KHR-4260	2.6	10	24	60	3	9,900
KHR-4261	2.61	10	24	60	3	10,600
KHR-4262	2.62	10	24	60	3	10,600
KHR-4263	2.63	10	24	60	3	10,600

品番 Code No.	刃径 D Flute Diameter	刃長 ℓ Flute Length	有効長ℓ1 Effective Length	全長 L Total Length	柄径 d Shank Diameter	標準価格 Retail Price
KHR-4264	2.64	10	24	60	3	10,600
KHR-4265	2.65	10	24	60	3	10,600
KHR-4266	2.66	10	24	60	3	10,600
KHR-4267	2.67	10	24	60	3	10,600
KHR-4268	2.68	10	24	60	3	10,600
KHR-4269	2.69	10	24	60	3	10,600
KHR-4270	2.7	10	24	60	3	9,900
KHR-4271	2.71	10	24	60	3	10,600
KHR-4272	2.72	10	24	60	3	10,600
KHR-4273	2.73	10	24	60	3	10,600
KHR-4274	2.74	10	24	60	3	10,600
KHR-4275	2.75	10	24	60	3	10,600
KHR-4276	2.76	10	24	60	3	10,600
KHR-4277	2.77	10	24	60	3	10,600
KHR-4278	2.78	10	24	60	3	10,600
KHR-4279	2.79	10	24	60	3	10,600
KHR-4280	2.8	10	24	60	3	9,900
KHR-4281	2.81	10	24	60	3	10,600
KHR-4282	2.82	10	24	60	3	10,600
KHR-4283	2.83	10	24	60	3	10,600
KHR-4284	2.84	10	24	60	3	10,600
KHR-4285	2.85	10	24	60	3	10,600
KHR-4286	2.86	10	24	60	3	10,600
KHR-4287	2.87	10	24	60	3	10,600
KHR-4288	2.88	10	24	60	3	10,600
KHR-4289	2.89	10	24	60	3	10,600
KHR-4290	2.9	10	24	60	3	9,900
KHR-4291	2.91	15	30	60	3	11,500
KHR-4292	2.92	15	30	60	3	11,500
KHR-4293	2.93	15	30	60	3	11,500
KHR-4294	2.94	15	30	60	3	11,500
KHR-4295	2.95	15	30	60	3	11,500
KHR-4296	2.96	15	30	60	3	11,500
KHR-4297	2.97	15	30	60	3	11,500
KHR-4298	2.98	15	30	60	3	11,500
KHR-4299	2.99	15	30	60	3	11,500
KHR-4300	3	15	30	60	3	10,600
KHR-4301	3.01	15	30	60	3	11,500
KHR-4302	3.02	15	30	60	3	11,500
KHR-4303	3.03	15	30	60	3	11,500
KHR-4304	3.04	15	30	60	3	11,500
KHR-4305	3.05	15	30	60	3	11,500
KHR-4306	3.06	15	30	60	3	11,500
KHR-4307	3.07	15	30	60	3	11,500
KHR-4308	3.08	15	30	60	3	11,500
KHR-4309	3.09	15	30	60	3	11,500
KHR-4310	3.1	15	30	70	4	11,500
KHR-4311	3.11	15	30	70	4	12,800

# KHR-4

品番 Code No.	刃径 D Flute Diameter	刃長 ℓ Flute Length	有効長ℓ <sub>1</sub> Effective Length	全長 L Total Length	柄径 d Shank Diameter	標準価格 Retail Price
KHR-4312	3.12	15	30	70	4	12,800
KHR-4313	3.13	15	30	70	4	12,800
KHR-4314	3.14	15	30	70	4	12,800
KHR-4315	3.15	15	30	70	4	12,800
KHR-4316	3.16	15	30	70	4	12,800
KHR-4317	3.17	15	30	70	4	12,800
KHR-4318	3.18	15	30	70	4	12,800
KHR-4319	3.19	15	30	70	4	12,800
KHR-4320	3.2	15	30	70	4	11,500
KHR-4321	3.21	15	30	70	4	12,800
KHR-4322	3.22	15	30	70	4	12,800
KHR-4323	3.23	15	30	70	4	12,800
KHR-4324	3.24	15	30	70	4	12,800
KHR-4325	3.25	15	30	70	4	12,800
KHR-4326	3.26	15	30	70	4	12,800
KHR-4327	3.27	15	30	70	4	12,800
KHR-4328	3.28	15	30	70	4	12,800
KHR-4329	3.29	15	30	70	4	12,800
KHR-4330	3.3	15	30	70	4	11,500
KHR-4331	3.31	15	30	70	4	12,800
KHR-4332	3.32	15	30	70	4	12,800
KHR-4333	3.33	15	30	70	4	12,800
KHR-4334	3.34	15	30	70	4	12,800
KHR-4335	3.35	15	30	70	4	12,800
KHR-4336	3.36	15	30	70	4	12,800
KHR-4337	3.37	15	30	70	4	12,800
KHR-4338	3.38	15	30	70	4	12,800
KHR-4339	3.39	15	30	70	4	12,800
KHR-4340	3.4	15	30	70	4	11,500
KHR-4341	3.41	15	30	70	4	12,800
KHR-4342	3.42	15	30	70	4	12,800
KHR-4343	3.43	15	30	70	4	12,800
KHR-4344	3.44	15	30	70	4	12,800
KHR-4345	3.45	15	30	70	4	12,800
KHR-4346	3.46	15	30	70	4	12,800
KHR-4347	3.47	15	30	70	4	12,800
KHR-4348	3.48	15	30	70	4	12,800
KHR-4349	3.49	15	30	70	4	12,800
KHR-4350	3.5	15	30	70	4	11,500
KHR-4351	3.51	15	30	70	4	12,800
KHR-4352	3.52	15	30	70	4	12,800
KHR-4353	3.53	15	30	70	4	12,800
KHR-4354	3.54	15	30	70	4	12,800
KHR-4355	3.55	15	30	70	4	12,800
KHR-4356	3.56	15	30	70	4	12,800
KHR-4357	3.57	15	30	70	4	12,800
KHR-4358	3.58	15	30	70	4	12,800
KHR-4359	3.59	15	30	70	4	12,800

品番 Code No.	刃径 D Flute Diameter	刃長 ℓ Flute Length	有効長ℓ <sub>1</sub> Effective Length	全長 L Total Length	柄径 d Shank Diameter	標準価格 Retail Price
KHR-4360	3.6	15	30	70	4	11,500
KHR-4361	3.61	15	30	70	4	12,800
KHR-4362	3.62	15	30	70	4	12,800
KHR-4363	3.63	15	30	70	4	12,800
KHR-4364	3.64	15	30	70	4	12,800
KHR-4365	3.65	15	30	70	4	12,800
KHR-4366	3.66	15	30	70	4	12,800
KHR-4367	3.67	15	30	70	4	12,800
KHR-4368	3.68	15	30	70	4	12,800
KHR-4369	3.69	15	30	70	4	12,800
KHR-4370	3.7	15	30	70	4	11,500
KHR-4371	3.71	15	30	70	4	12,800
KHR-4372	3.72	15	30	70	4	12,800
KHR-4373	3.73	15	30	70	4	12,800
KHR-4374	3.74	15	30	70	4	12,800
KHR-4375	3.75	15	30	70	4	12,800
KHR-4376	3.76	15	30	70	4	12,800
KHR-4377	3.77	15	30	70	4	12,800
KHR-4378	3.78	15	30	70	4	12,800
KHR-4379	3.79	15	30	70	4	12,800
KHR-4380	3.8	15	30	70	4	11,500
KHR-4381	3.81	15	30	70	4	12,800
KHR-4382	3.82	15	30	70	4	12,800
KHR-4383	3.83	15	30	70	4	12,800
KHR-4384	3.84	15	30	70	4	12,800
KHR-4385	3.85	15	30	70	4	12,800
KHR-4386	3.86	15	30	70	4	12,800
KHR-4387	3.87	15	30	70	4	12,800
KHR-4388	3.88	15	30	70	4	12,800
KHR-4389	3.89	15	30	70	4	12,800
KHR-4390	3.9	15	30	70	4	11,500
KHR-4391	3.91	20	35	70	4	13,400
KHR-4392	3.92	20	35	70	4	13,400
KHR-4393	3.93	20	35	70	4	13,400
KHR-4394	3.94	20	35	70	4	13,400
KHR-4395	3.95	20	35	70	4	13,400
KHR-4396	3.96	20	35	70	4	13,400
KHR-4397	3.97	20	35	70	4	13,400
KHR-4398	3.98	20	35	70	4	13,400
KHR-4399	3.99	20	35	70	4	13,400
KHR-4400	4	20	35	70	4	12,000
KHR-4401	4.01	20	35	70	4	13,400
KHR-4402	4.02	20	35	70	4	13,400
KHR-4403	4.03	20	35	70	4	13,400
KHR-4404	4.04	20	35	70	4	13,400
KHR-4405	4.05	20	35	70	4	13,400
KHR-4406	4.06	20	35	70	4	13,400
KHR-4407	4.07	20	35	70	4	13,400

超硬製品

Tungsten Carbide



# KHR-4

品番 Code No.	刃径 D Flute Diameter	刃長 ℓ Flute Length	有効長ℓ1 Effective Length	全長 L Total Length	柄径 d Shank Diameter	標準価格 Retail Price
KHR-4408	4.08	20	35	70	4	13,400
KHR-4409	4.09	20	35	70	4	13,400
KHR-4410	4.1	20	35	80	6	12,800
KHR-4411	4.11	20	35	80	6	14,300
KHR-4412	4.12	20	35	80	6	14,300
KHR-4413	4.13	20	35	80	6	14,300
KHR-4414	4.14	20	35	80	6	14,300
KHR-4415	4.15	20	35	80	6	14,300
KHR-4416	4.16	20	35	80	6	14,300
KHR-4417	4.17	20	35	80	6	14,300
KHR-4418	4.18	20	35	80	6	14,300
KHR-4419	4.19	20	35	80	6	14,300
KHR-4420	4.2	20	35	80	6	12,800
KHR-4421	4.21	20	35	80	6	14,300
KHR-4422	4.22	20	35	80	6	14,300
KHR-4423	4.23	20	35	80	6	14,300
KHR-4424	4.24	20	35	80	6	14,300
KHR-4425	4.25	20	35	80	6	14,300
KHR-4426	4.26	20	35	80	6	14,300
KHR-4427	4.27	20	35	80	6	14,300
KHR-4428	4.28	20	35	80	6	14,300
KHR-4429	4.29	20	35	80	6	14,300
KHR-4430	4.3	20	35	80	6	12,800
KHR-4431	4.31	20	35	80	6	14,300
KHR-4432	4.32	20	35	80	6	14,300
KHR-4433	4.33	20	35	80	6	14,300
KHR-4434	4.34	20	35	80	6	14,300
KHR-4435	4.35	20	35	80	6	14,300
KHR-4436	4.36	20	35	80	6	14,300
KHR-4437	4.37	20	35	80	6	14,300
KHR-4438	4.38	20	35	80	6	14,300
KHR-4439	4.39	20	35	80	6	14,300
KHR-4440	4.4	20	35	80	6	12,800
KHR-4441	4.41	20	35	80	6	14,300
KHR-4442	4.42	20	35	80	6	14,300
KHR-4443	4.43	20	35	80	6	14,300
KHR-4444	4.44	20	35	80	6	14,300
KHR-4445	4.45	20	35	80	6	14,300
KHR-4446	4.46	20	35	80	6	14,300
KHR-4447	4.47	20	35	80	6	14,300
KHR-4448	4.48	20	35	80	6	14,300
KHR-4449	4.49	20	35	80	6	14,300
KHR-4450	4.5	20	35	80	6	12,800
KHR-4451	4.51	20	35	80	6	14,300
KHR-4452	4.52	20	35	80	6	14,300
KHR-4453	4.53	20	35	80	6	14,300
KHR-4454	4.54	20	35	80	6	14,300
KHR-4455	4.55	20	35	80	6	14,300

品番 Code No.	刃径 D Flute Diameter	刃長 ℓ Flute Length	有効長ℓ1 Effective Length	全長 L Total Length	柄径 d Shank Diameter	標準価格 Retail Price
KHR-4456	4.56	20	35	80	6	14,300
KHR-4457	4.57	20	35	80	6	14,300
KHR-4458	4.58	20	35	80	6	14,300
KHR-4459	4.59	20	35	80	6	14,300
KHR-4460	4.6	20	35	80	6	12,800
KHR-4461	4.61	20	35	80	6	14,300
KHR-4462	4.62	20	35	80	6	14,300
KHR-4463	4.63	20	35	80	6	14,300
KHR-4464	4.64	20	35	80	6	14,300
KHR-4465	4.65	20	35	80	6	14,300
KHR-4466	4.66	20	35	80	6	14,300
KHR-4467	4.67	20	35	80	6	14,300
KHR-4468	4.68	20	35	80	6	14,300
KHR-4469	4.69	20	35	80	6	14,300
KHR-4470	4.7	20	35	80	6	12,800
KHR-4471	4.71	20	35	80	6	14,300
KHR-4472	4.72	20	35	80	6	14,300
KHR-4473	4.73	20	35	80	6	14,300
KHR-4474	4.74	20	35	80	6	14,300
KHR-4475	4.75	20	35	80	6	14,300
KHR-4476	4.76	20	35	80	6	14,300
KHR-4477	4.77	20	35	80	6	14,300
KHR-4478	4.78	20	35	80	6	14,300
KHR-4479	4.79	20	35	80	6	14,300
KHR-4480	4.8	20	35	80	6	12,800
KHR-4481	4.81	20	35	80	6	14,300
KHR-4482	4.82	20	35	80	6	14,300
KHR-4483	4.83	20	35	80	6	14,300
KHR-4484	4.84	20	35	80	6	14,300
KHR-4485	4.85	20	35	80	6	14,300
KHR-4486	4.86	20	35	80	6	14,300
KHR-4487	4.87	20	35	80	6	14,300
KHR-4488	4.88	20	35	80	6	14,300
KHR-4489	4.89	20	35	80	6	14,300
KHR-4490	4.9	20	35	80	6	12,800
KHR-4491	4.91	24	40	80	6	14,900
KHR-4492	4.92	24	40	80	6	14,900
KHR-4493	4.93	24	40	80	6	14,900
KHR-4494	4.94	24	40	80	6	14,900
KHR-4495	4.95	24	40	80	6	14,900
KHR-4496	4.96	24	40	80	6	14,900
KHR-4497	4.97	24	40	80	6	14,900
KHR-4498	4.98	24	40	80	6	14,900
KHR-4499	4.99	24	40	80	6	14,900
KHR-4500	5	24	40	80	6	13,400
KHR-4501	5.01	24	40	80	6	14,900
KHR-4502	5.02	24	40	80	6	14,900
KHR-4503	5.03	24	40	80	6	14,900

# KHR-4

品番 Code No.	刃径 D Flute Diameter	刃長 ℓ Flute Length	有効長ℓ1 Effective Length	全長 L Total Length	柄径 d Shank Diameter	標準価格 Retail Price
KHR-4504	5.04	24	40	80	6	14,900
KHR-4505	5.05	24	40	80	6	14,900
KHR-4506	5.06	24	40	80	6	14,900
KHR-4507	5.07	24	40	80	6	14,900
KHR-4508	5.08	24	40	80	6	14,900
KHR-4509	5.09	24	40	80	6	14,900
KHR-4510	5.1	24	40	80	6	13,400
KHR-4511	5.11	24	40	80	6	14,900
KHR-4512	5.12	24	40	80	6	14,900
KHR-4513	5.13	24	40	80	6	14,900
KHR-4514	5.14	24	40	80	6	14,900
KHR-4515	5.15	24	40	80	6	14,900
KHR-4516	5.16	24	40	80	6	14,900
KHR-4517	5.17	24	40	80	6	14,900
KHR-4518	5.18	24	40	80	6	14,900
KHR-4519	5.19	24	40	80	6	14,900
KHR-4520	5.2	24	40	80	6	13,400
KHR-4521	5.21	24	40	80	6	14,900
KHR-4522	5.22	24	40	80	6	14,900
KHR-4523	5.23	24	40	80	6	14,900
KHR-4524	5.24	24	40	80	6	14,900
KHR-4525	5.25	24	40	80	6	14,900
KHR-4526	5.26	24	40	80	6	14,900
KHR-4527	5.27	24	40	80	6	14,900
KHR-4528	5.28	24	40	80	6	14,900
KHR-4529	5.29	24	40	80	6	14,900
KHR-4530	5.3	24	40	80	6	13,400
KHR-4531	5.31	24	40	80	6	14,900
KHR-4532	5.32	24	40	80	6	14,900
KHR-4533	5.33	24	40	80	6	14,900
KHR-4534	5.34	24	40	80	6	14,900
KHR-4535	5.35	24	40	80	6	14,900
KHR-4536	5.36	24	40	80	6	14,900
KHR-4537	5.37	24	40	80	6	14,900
KHR-4538	5.38	24	40	80	6	14,900
KHR-4539	5.39	24	40	80	6	14,900
KHR-4540	5.4	24	40	80	6	13,400
KHR-4541	5.41	24	40	80	6	14,900
KHR-4542	5.42	24	40	80	6	14,900
KHR-4543	5.43	24	40	80	6	14,900
KHR-4544	5.44	24	40	80	6	14,900
KHR-4545	5.45	24	40	80	6	14,900
KHR-4546	5.46	24	40	80	6	14,900
KHR-4547	5.47	24	40	80	6	14,900
KHR-4548	5.48	24	40	80	6	14,900
KHR-4549	5.49	24	40	80	6	14,900
KHR-4550	5.5	24	40	80	6	13,400
KHR-4551	5.51	24	40	80	6	14,900

品番 Code No.	刃径 D Flute Diameter	刃長 ℓ Flute Length	有効長ℓ1 Effective Length	全長 L Total Length	柄径 d Shank Diameter	標準価格 Retail Price
KHR-4552	5.52	24	40	80	6	14,900
KHR-4553	5.53	24	40	80	6	14,900
KHR-4554	5.54	24	40	80	6	14,900
KHR-4555	5.55	24	40	80	6	14,900
KHR-4556	5.56	24	40	80	6	14,900
KHR-4557	5.57	24	40	80	6	14,900
KHR-4558	5.58	24	40	80	6	14,900
KHR-4559	5.59	24	40	80	6	14,900
KHR-4560	5.6	24	40	80	6	13,400
KHR-4561	5.61	24	40	80	6	14,900
KHR-4562	5.62	24	40	80	6	14,900
KHR-4563	5.63	24	40	80	6	14,900
KHR-4564	5.64	24	40	80	6	14,900
KHR-4565	5.65	24	40	80	6	14,900
KHR-4566	5.66	24	40	80	6	14,900
KHR-4567	5.67	24	40	80	6	14,900
KHR-4568	5.68	24	40	80	6	14,900
KHR-4569	5.69	24	40	80	6	14,900
KHR-4570	5.7	24	40	80	6	13,400
KHR-4571	5.71	24	40	80	6	14,900
KHR-4572	5.72	24	40	80	6	14,900
KHR-4573	5.73	24	40	80	6	14,900
KHR-4574	5.74	24	40	80	6	14,900
KHR-4575	5.75	24	40	80	6	14,900
KHR-4576	5.76	24	40	80	6	14,900
KHR-4577	5.77	24	40	80	6	14,900
KHR-4578	5.78	24	40	80	6	14,900
KHR-4579	5.79	24	40	80	6	14,900
KHR-4580	5.8	24	40	80	6	13,400
KHR-4581	5.81	24	40	80	6	14,900
KHR-4582	5.82	24	40	80	6	14,900
KHR-4583	5.83	24	40	80	6	14,900
KHR-4584	5.84	24	40	80	6	14,900
KHR-4585	5.85	24	40	80	6	14,900
KHR-4586	5.86	24	40	80	6	14,900
KHR-4587	5.87	24	40	80	6	14,900
KHR-4588	5.88	24	40	80	6	14,900
KHR-4589	5.89	24	40	80	6	14,900
KHR-4590	5.9	24	40	80	6	13,400
KHR-4591	5.91	24	40	80	6	14,900
KHR-4592	5.92	24	40	80	6	14,900
KHR-4593	5.93	24	40	80	6	14,900
KHR-4594	5.94	24	40	80	6	14,900
KHR-4595	5.95	24	40	80	6	14,900
KHR-4596	5.96	24	40	80	6	14,900
KHR-4597	5.97	24	40	80	6	14,900
KHR-4598	5.98	24	40	80	6	14,900
KHR-4599	5.99	24	40	80	6	14,900

超硬製品

Tungsten Carbide

# KHR-4

品番 Code No.	刃径 D Flute Diameter	刃長 ℓ Flute Length	有効長ℓ1 Effective Length	全長 L Total Length	柄径 d Shank Diameter	標準価格 Retail Price
KHR-4600	6	24	40	80	6	13,400
KHR-4601	6.01	24	40	80	6	14,900
KHR-4602	6.02	24	40	80	6	14,900
KHR-4603	6.03	24	40	80	6	14,900
KHR-4604	6.04	24	40	80	6	14,900
KHR-4605	6.05	24	40	80	6	14,900
KHR-4610	6.1	25	45	100	8	19,200
KHR-4615	6.15	25	45	100	8	20,900
KHR-4620	6.2	25	45	100	8	19,200
KHR-4625	6.25	25	45	100	8	20,900
KHR-4630	6.3	25	45	100	8	19,200
KHR-4635	6.35	25	45	100	8	20,900
KHR-4640	6.4	25	45	100	8	19,200
KHR-4645	6.45	25	45	100	8	20,900
KHR-4650	6.5	25	45	100	8	19,200
KHR-4655	6.55	25	45	100	8	20,900
KHR-4660	6.6	25	45	100	8	19,200
KHR-4665	6.65	25	45	100	8	20,900
KHR-4670	6.7	25	45	100	8	19,200
KHR-4675	6.75	25	45	100	8	20,900
KHR-4680	6.8	25	45	100	8	19,200
KHR-4685	6.85	25	45	100	8	20,900
KHR-4690	6.9	25	45	100	8	19,200
KHR-4695	6.95	25	45	100	8	20,900
KHR-4696	6.96	25	45	100	8	20,900
KHR-4697	6.97	25	45	100	8	20,900
KHR-4698	6.98	25	45	100	8	20,900
KHR-4699	6.99	25	45	100	8	20,900
KHR-4700	7	25	45	100	8	19,200
KHR-4701	7.01	25	45	100	8	20,900
KHR-4702	7.02	25	45	100	8	20,900
KHR-4703	7.03	25	45	100	8	20,900
KHR-4704	7.04	25	45	100	8	20,900
KHR-4705	7.05	25	45	100	8	20,900
KHR-4710	7.1	25	45	100	8	19,200
KHR-4715	7.15	25	45	100	8	20,900
KHR-4720	7.2	25	45	100	8	19,200
KHR-4725	7.25	25	45	100	8	20,900
KHR-4730	7.3	25	45	100	8	19,200
KHR-4735	7.35	25	45	100	8	20,900
KHR-4740	7.4	25	45	100	8	19,200
KHR-4745	7.45	25	45	100	8	20,900
KHR-4750	7.5	25	45	100	8	19,200
KHR-4755	7.55	25	45	100	8	20,900
KHR-4760	7.6	25	45	100	8	19,200
KHR-4765	7.65	25	45	100	8	20,900
KHR-4770	7.7	25	45	100	8	19,200
KHR-4775	7.75	25	45	100	8	20,900

品番 Code No.	刃径 D Flute Diameter	刃長 ℓ Flute Length	有効長ℓ1 Effective Length	全長 L Total Length	柄径 d Shank Diameter	標準価格 Retail Price
KHR-4780	7.8	25	45	100	8	19,200
KHR-4785	7.85	25	45	100	8	20,900
KHR-4790	7.9	25	45	100	8	19,200
KHR-4795	7.95	25	45	100	8	20,900
KHR-4796	7.96	25	45	100	8	20,900
KHR-4797	7.97	25	45	100	8	20,900
KHR-4798	7.98	25	45	100	8	20,900
KHR-4799	7.99	25	45	100	8	20,900
KHR-4800	8	25	45	100	8	19,200
KHR-4801	8.01	25	45	100	8	20,900
KHR-4802	8.02	25	45	100	8	20,900
KHR-4803	8.03	25	45	100	8	20,900
KHR-4804	8.04	25	45	100	8	20,900
KHR-4805	8.05	25	45	100	8	20,900
KHR-4810	8.1	25	50	100	10	23,900
KHR-4815	8.15	25	50	100	10	26,400
KHR-4820	8.2	25	50	100	10	23,900
KHR-4825	8.25	25	50	100	10	26,400
KHR-4830	8.3	25	50	100	10	23,900
KHR-4835	8.35	25	50	100	10	26,400
KHR-4840	8.4	25	50	100	10	23,900
KHR-4845	8.45	25	50	100	10	26,400
KHR-4850	8.5	25	50	100	10	23,900
KHR-4855	8.55	25	50	100	10	26,400
KHR-4860	8.6	25	50	100	10	23,900
KHR-4865	8.65	25	50	100	10	26,400
KHR-4870	8.7	25	50	100	10	23,900
KHR-4875	8.75	25	50	100	10	26,400
KHR-4880	8.8	25	50	100	10	23,900
KHR-4885	8.85	25	50	100	10	26,400
KHR-4890	8.9	25	50	100	10	23,900
KHR-4895	8.95	25	50	100	10	26,400
KHR-4896	8.96	25	50	100	10	26,400
KHR-4897	8.97	25	50	100	10	26,400
KHR-4898	8.98	25	50	100	10	26,400
KHR-4899	8.99	25	50	100	10	26,400
KHR-4900	9	25	50	100	10	23,900
KHR-4901	9.01	25	50	100	10	26,400
KHR-4902	9.02	25	50	100	10	26,400
KHR-4903	9.03	25	50	100	10	26,400
KHR-4904	9.04	25	50	100	10	26,400
KHR-4905	9.05	25	50	100	10	26,400
KHR-4910	9.1	25	50	100	10	23,900
KHR-4915	9.15	25	50	100	10	26,400
KHR-4920	9.2	25	50	100	10	23,900
KHR-4925	9.25	25	50	100	10	26,400
KHR-4930	9.3	25	50	100	10	23,900
KHR-4935	9.35	25	50	100	10	26,400



# KHRA-4

## 超硬底刃付リーマ

Tungsten Carbide Reamer with Bottom Flute

TiAlN Coating

■底刃が付いているので止まり穴の加工などに最適です  
Best for stop hole processing due to having bottom flute

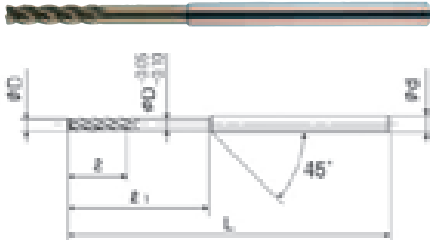

超微粒子合金 Micro Grain Tungsten Carbide



刃径の許容差 Flute Diameter Tolerance  
 $D \leq 3.09$   $+0.005 \sim 0$   
 $3.1 < D \leq 12.03$   $+0.007 \sim 0$



柄径の許容差 Shank Diameter Tolerance  
 $d = 3$   $0 \sim -0.006$   
 $3 < d \leq 6.05$   $0 \sim -0.008$   
 $8 < d \leq 10$   $0 \sim -0.009$   
 $d = 12$   $0 \sim -0.011$



ネジレ角 右ネジレ35° Twist Angle 35°



喰付寸法 (K=喰付角片角45°)  
 Chamfer Size (K=Chamfer Angle Single 45°)  
 $C = 0.1 \pm 0.03$   $\phi 0.5 \sim \phi 1.99$   
 $C = 0.15 \pm 0.03$   $\phi 2 \sim \phi 3.09$   
 $C = 0.2 \pm 0.03$   $\phi 3.1 \sim \phi 7.05$   
 $C = 0.3 \pm 0.03$   $\phi 7.1 \sim \phi 10.05$   
 $C = 0.4 \pm 0.03$   $\phi 10.1 \sim \phi 12.03$

TiAlNコート

TiAlN コート TiAlN Coating

●切削条件表はP227に記載

単位 [寸法: mm / 価格: 円]

●Cutting conditions are recommended on page 227.

Unit [size: mm / Retail Price: JPY]

品番 Code No.	刃径 D Flute Diameter	刃長 ℓ Flute Length	有効長 ℓ1 Effective Length	全長 L Total Length	柄径 d Shank Diameter	標準価格 Retail Price
KHRA-4050	0.5	4	10	50	3	11,900
KHRA-4051	0.51	4	10	50	3	12,800
KHRA-4052	0.52	4	10	50	3	12,800
KHRA-4053	0.53	4	10	50	3	12,800
KHRA-4054	0.54	4	10	50	3	12,800
KHRA-4055	0.55	4	10	50	3	12,800
KHRA-4056	0.56	4	10	50	3	12,800
KHRA-4057	0.57	4	10	50	3	12,800
KHRA-4058	0.58	4	10	50	3	12,800
KHRA-4059	0.59	4	10	50	3	12,800
KHRA-4060	0.6	4	10	50	3	11,900
KHRA-4061	0.61	4	10	50	3	12,800
KHRA-4062	0.62	4	10	50	3	12,800
KHRA-4063	0.63	4	10	50	3	12,800
KHRA-4064	0.64	4	10	50	3	12,800
KHRA-4065	0.65	4	10	50	3	12,800
KHRA-4066	0.66	4	10	50	3	12,800
KHRA-4067	0.67	4	10	50	3	12,800
KHRA-4068	0.68	4	10	50	3	12,800
KHRA-4069	0.69	4	10	50	3	12,800

品番 Code No.	刃径 D Flute Diameter	刃長 ℓ Flute Length	有効長 ℓ1 Effective Length	全長 L Total Length	柄径 d Shank Diameter	標準価格 Retail Price
KHRA-4070	0.7	4	10	50	3	11,900
KHRA-4071	0.71	4	10	50	3	12,800
KHRA-4072	0.72	4	10	50	3	12,800
KHRA-4073	0.73	4	10	50	3	12,800
KHRA-4074	0.74	4	10	50	3	12,800
KHRA-4075	0.75	4	10	50	3	12,800
KHRA-4076	0.76	4	10	50	3	12,800
KHRA-4077	0.77	4	10	50	3	12,800
KHRA-4078	0.78	4	10	50	3	12,800
KHRA-4079	0.79	5	12	50	3	12,800
KHRA-4080	0.8	5	12	50	3	11,600
KHRA-4081	0.81	5	12	50	3	12,300
KHRA-4082	0.82	5	12	50	3	12,300
KHRA-4083	0.83	5	12	50	3	12,300
KHRA-4084	0.84	5	12	50	3	12,300
KHRA-4085	0.85	5	12	50	3	12,300
KHRA-4086	0.86	5	12	50	3	12,300
KHRA-4087	0.87	5	12	50	3	12,300
KHRA-4088	0.88	5	12	50	3	12,300
KHRA-4089	0.89	5	12	50	3	12,300
KHRA-4090	0.9	5	12	50	3	11,600
KHRA-4091	0.91	5	12	50	3	12,300
KHRA-4092	0.92	5	12	50	3	12,300
KHRA-4093	0.93	5	12	50	3	12,300
KHRA-4094	0.94	5	12	50	3	12,300
KHRA-4095	0.95	5	12	50	3	12,300
KHRA-4096	0.96	5	12	50	3	12,300
KHRA-4097	0.97	5	12	50	3	12,300
KHRA-4098	0.98	5	12	50	3	12,300
KHRA-4099	0.99	5	12	50	3	12,300
KHRA-4100	1	6	15	60	3	11,400
KHRA-4101	1.01	6	15	60	3	12,000
KHRA-4102	1.02	6	15	60	3	12,000
KHRA-4103	1.03	6	15	60	3	12,000
KHRA-4104	1.04	6	15	60	3	12,000
KHRA-4105	1.05	6	15	60	3	12,000
KHRA-4106	1.06	6	15	60	3	12,000
KHRA-4107	1.07	6	15	60	3	12,000
KHRA-4108	1.08	6	15	60	3	12,000
KHRA-4109	1.09	6	15	60	3	12,000
KHRA-4110	1.1	6	15	60	3	11,400
KHRA-4111	1.11	6	15	60	3	12,000
KHRA-4112	1.12	6	15	60	3	12,000
KHRA-4113	1.13	6	15	60	3	12,000
KHRA-4114	1.14	6	15	60	3	12,000
KHRA-4115	1.15	6	15	60	3	12,000
KHRA-4116	1.16	6	15	60	3	12,000
KHRA-4117	1.17	6	15	60	3	12,000

# KHRA-4

品番 Code No.	刃径 D Flute Diameter	刃長 ℓ Flute Length	有効長 ℓ1 Effective Length	全長 L Total Length	柄径 d Shank Diameter	標準価格 Retail Price
KHRA-4118	1.18	6	15	60	3	12,000
KHRA-4119	1.19	6	15	60	3	12,000
KHRA-4120	1.2	6	15	60	3	11,400
KHRA-4121	1.21	6	15	60	3	12,000
KHRA-4122	1.22	6	15	60	3	12,000
KHRA-4123	1.23	6	15	60	3	12,000
KHRA-4124	1.24	6	15	60	3	12,000
KHRA-4125	1.25	6	15	60	3	12,000
KHRA-4126	1.26	6	15	60	3	12,000
KHRA-4127	1.27	6	15	60	3	12,000
KHRA-4128	1.28	6	15	60	3	12,000
KHRA-4129	1.29	6	15	60	3	12,000
KHRA-4130	1.3	6	15	60	3	11,400
KHRA-4131	1.31	6	15	60	3	12,000
KHRA-4132	1.32	6	15	60	3	12,000
KHRA-4133	1.33	6	15	60	3	12,000
KHRA-4134	1.34	6	15	60	3	12,000
KHRA-4135	1.35	6	15	60	3	12,000
KHRA-4136	1.36	6	15	60	3	12,000
KHRA-4137	1.37	6	15	60	3	12,000
KHRA-4138	1.38	6	15	60	3	12,000
KHRA-4139	1.39	6	15	60	3	12,000
KHRA-4140	1.4	6	15	60	3	11,400
KHRA-4141	1.41	6	15	60	3	12,000
KHRA-4142	1.42	6	15	60	3	12,000
KHRA-4143	1.43	6	15	60	3	12,000
KHRA-4144	1.44	6	15	60	3	12,000
KHRA-4145	1.45	6	15	60	3	12,000
KHRA-4146	1.46	6	15	60	3	12,000
KHRA-4147	1.47	6	15	60	3	12,000
KHRA-4148	1.48	6	15	60	3	12,000
KHRA-4149	1.49	6	15	60	3	12,000
KHRA-4150	1.5	8	20	60	3	11,400
KHRA-4151	1.51	8	20	60	3	12,000
KHRA-4152	1.52	8	20	60	3	12,000
KHRA-4153	1.53	8	20	60	3	12,000
KHRA-4154	1.54	8	20	60	3	12,000
KHRA-4155	1.55	8	20	60	3	12,000
KHRA-4156	1.56	8	20	60	3	12,000
KHRA-4157	1.57	8	20	60	3	12,000
KHRA-4158	1.58	8	20	60	3	12,000
KHRA-4159	1.59	8	20	60	3	12,000
KHRA-4160	1.6	8	20	60	3	11,400
KHRA-4161	1.61	8	20	60	3	12,000
KHRA-4162	1.62	8	20	60	3	12,000
KHRA-4163	1.63	8	20	60	3	12,000
KHRA-4164	1.64	8	20	60	3	12,000
KHRA-4165	1.65	8	20	60	3	12,000

品番 Code No.	刃径 D Flute Diameter	刃長 ℓ Flute Length	有効長 ℓ1 Effective Length	全長 L Total Length	柄径 d Shank Diameter	標準価格 Retail Price
KHRA-4166	1.66	8	20	60	3	12,000
KHRA-4167	1.67	8	20	60	3	12,000
KHRA-4168	1.68	8	20	60	3	12,000
KHRA-4169	1.69	8	20	60	3	12,000
KHRA-4170	1.7	8	20	60	3	11,400
KHRA-4171	1.71	8	20	60	3	12,000
KHRA-4172	1.72	8	20	60	3	12,000
KHRA-4173	1.73	8	20	60	3	12,000
KHRA-4174	1.74	8	20	60	3	12,000
KHRA-4175	1.75	8	20	60	3	12,000
KHRA-4176	1.76	8	20	60	3	12,000
KHRA-4177	1.77	8	20	60	3	12,000
KHRA-4178	1.78	8	20	60	3	12,000
KHRA-4179	1.79	8	20	60	3	12,000
KHRA-4180	1.8	8	20	60	3	11,400
KHRA-4181	1.81	8	20	60	3	12,000
KHRA-4182	1.82	8	20	60	3	12,000
KHRA-4183	1.83	8	20	60	3	12,000
KHRA-4184	1.84	8	20	60	3	12,000
KHRA-4185	1.85	8	20	60	3	12,000
KHRA-4186	1.86	8	20	60	3	12,000
KHRA-4187	1.87	8	20	60	3	12,000
KHRA-4188	1.88	8	20	60	3	12,000
KHRA-4189	1.89	8	20	60	3	12,000
KHRA-4190	1.9	8	20	60	3	11,400
KHRA-4191	1.91	10	24	60	3	12,000
KHRA-4192	1.92	10	24	60	3	12,000
KHRA-4193	1.93	10	24	60	3	12,000
KHRA-4194	1.94	10	24	60	3	12,000
KHRA-4195	1.95	10	24	60	3	12,000
KHRA-4196	1.96	10	24	60	3	12,000
KHRA-4197	1.97	10	24	60	3	12,000
KHRA-4198	1.98	10	24	60	3	12,000
KHRA-4199	1.99	10	24	60	3	12,000
KHRA-4200	2	10	24	60	3	11,400
KHRA-4201	2.01	10	24	60	3	12,000
KHRA-4202	2.02	10	24	60	3	12,000
KHRA-4203	2.03	10	24	60	3	12,000
KHRA-4204	2.04	10	24	60	3	12,000
KHRA-4205	2.05	10	24	60	3	12,000
KHRA-4206	2.06	10	24	60	3	12,000
KHRA-4207	2.07	10	24	60	3	12,000
KHRA-4208	2.08	10	24	60	3	12,000
KHRA-4209	2.09	10	24	60	3	12,000
KHRA-4210	2.1	10	24	60	3	11,400
KHRA-4211	2.11	10	24	60	3	12,000
KHRA-4212	2.12	10	24	60	3	12,000
KHRA-4213	2.13	10	24	60	3	12,000

超硬製品

Tungsten Carbide

# KHRA-4

品番 Code No.	刃径 D Flute Diameter	刃長 ℓ Flute Length	有効長 ℓ1 Effective Length	全長 L Total Length	柄径 d Shank Diameter	標準価格 Retail Price
KHRA-4214	2.14	10	24	60	3	12,000
KHRA-4215	2.15	10	24	60	3	12,000
KHRA-4216	2.16	10	24	60	3	12,000
KHRA-4217	2.17	10	24	60	3	12,000
KHRA-4218	2.18	10	24	60	3	12,000
KHRA-4219	2.19	10	24	60	3	12,000
KHRA-4220	2.2	10	24	60	3	11,400
KHRA-4221	2.21	10	24	60	3	12,000
KHRA-4222	2.22	10	24	60	3	12,000
KHRA-4223	2.23	10	24	60	3	12,000
KHRA-4224	2.24	10	24	60	3	12,000
KHRA-4225	2.25	10	24	60	3	12,000
KHRA-4226	2.26	10	24	60	3	12,000
KHRA-4227	2.27	10	24	60	3	12,000
KHRA-4228	2.28	10	24	60	3	12,000
KHRA-4229	2.29	10	24	60	3	12,000
KHRA-4230	2.3	10	24	60	3	11,400
KHRA-4231	2.31	10	24	60	3	12,000
KHRA-4232	2.32	10	24	60	3	12,000
KHRA-4233	2.33	10	24	60	3	12,000
KHRA-4234	2.34	10	24	60	3	12,000
KHRA-4235	2.35	10	24	60	3	12,000
KHRA-4236	2.36	10	24	60	3	12,000
KHRA-4237	2.37	10	24	60	3	12,000
KHRA-4238	2.38	10	24	60	3	12,000
KHRA-4239	2.39	10	24	60	3	12,000
KHRA-4240	2.4	10	24	60	3	11,400
KHRA-4241	2.41	10	24	60	3	12,000
KHRA-4242	2.42	10	24	60	3	12,000
KHRA-4243	2.43	10	24	60	3	12,000
KHRA-4244	2.44	10	24	60	3	12,000
KHRA-4245	2.45	10	24	60	3	12,000
KHRA-4246	2.46	10	24	60	3	12,000
KHRA-4247	2.47	10	24	60	3	12,000
KHRA-4248	2.48	10	24	60	3	12,000
KHRA-4249	2.49	10	24	60	3	12,000
KHRA-4250	2.5	10	24	60	3	11,400
KHRA-4251	2.51	10	24	60	3	12,000
KHRA-4252	2.52	10	24	60	3	12,000
KHRA-4253	2.53	10	24	60	3	12,000
KHRA-4254	2.54	10	24	60	3	12,000
KHRA-4255	2.55	10	24	60	3	12,000
KHRA-4256	2.56	10	24	60	3	12,000
KHRA-4257	2.57	10	24	60	3	12,000
KHRA-4258	2.58	10	24	60	3	12,000
KHRA-4259	2.59	10	24	60	3	12,000
KHRA-4260	2.6	10	24	60	3	11,400
KHRA-4261	2.61	10	24	60	3	12,000

品番 Code No.	刃径 D Flute Diameter	刃長 ℓ Flute Length	有効長 ℓ1 Effective Length	全長 L Total Length	柄径 d Shank Diameter	標準価格 Retail Price
KHRA-4262	2.62	10	24	60	3	12,000
KHRA-4263	2.63	10	24	60	3	12,000
KHRA-4264	2.64	10	24	60	3	12,000
KHRA-4265	2.65	10	24	60	3	12,000
KHRA-4266	2.66	10	24	60	3	12,000
KHRA-4267	2.67	10	24	60	3	12,000
KHRA-4268	2.68	10	24	60	3	12,000
KHRA-4269	2.69	10	24	60	3	12,000
KHRA-4270	2.7	10	24	60	3	11,400
KHRA-4271	2.71	10	24	60	3	12,000
KHRA-4272	2.72	10	24	60	3	12,000
KHRA-4273	2.73	10	24	60	3	12,000
KHRA-4274	2.74	10	24	60	3	12,000
KHRA-4275	2.75	10	24	60	3	12,000
KHRA-4276	2.76	10	24	60	3	12,000
KHRA-4277	2.77	10	24	60	3	12,000
KHRA-4278	2.78	10	24	60	3	12,000
KHRA-4279	2.79	10	24	60	3	12,000
KHRA-4280	2.8	10	24	60	3	11,400
KHRA-4281	2.81	10	24	60	3	12,000
KHRA-4282	2.82	10	24	60	3	12,000
KHRA-4283	2.83	10	24	60	3	12,000
KHRA-4284	2.84	10	24	60	3	12,000
KHRA-4285	2.85	10	24	60	3	12,000
KHRA-4286	2.86	10	24	60	3	12,000
KHRA-4287	2.87	10	24	60	3	12,000
KHRA-4288	2.88	10	24	60	3	12,000
KHRA-4289	2.89	10	24	60	3	12,000
KHRA-4290	2.9	10	24	60	3	11,400
KHRA-4291	2.91	15	30	60	3	12,800
KHRA-4292	2.92	15	30	60	3	12,800
KHRA-4293	2.93	15	30	60	3	12,800
KHRA-4294	2.94	15	30	60	3	12,800
KHRA-4295	2.95	15	30	60	3	12,800
KHRA-4296	2.96	15	30	60	3	12,800
KHRA-4297	2.97	15	30	60	3	12,800
KHRA-4298	2.98	15	30	60	3	12,800
KHRA-4299	2.99	15	30	60	3	12,800
KHRA-4300	3	15	30	60	3	12,000
KHRA-4301	3.01	15	30	60	3	12,800
KHRA-4302	3.02	15	30	60	3	12,800
KHRA-4303	3.03	15	30	60	3	12,800
KHRA-4304	3.04	15	30	60	3	12,800
KHRA-4305	3.05	15	30	60	3	12,800
KHRA-4306	3.06	15	30	60	3	12,800
KHRA-4307	3.07	15	30	60	3	12,800
KHRA-4308	3.08	15	30	60	3	12,800
KHRA-4309	3.09	15	30	60	3	12,800

# KHRA-4

品番 Code No.	刃径 D Flute Diameter	刃長 ℓ Flute Length	有効長 ℓ1 Effective Length	全長 L Total Length	柄径 d Shank Diameter	標準価格 Retail Price
KHRA-4310	3.1	15	30	70	4	12,700
KHRA-4311	3.11	15	30	70	4	14,000
KHRA-4312	3.12	15	30	70	4	14,000
KHRA-4313	3.13	15	30	70	4	14,000
KHRA-4314	3.14	15	30	70	4	14,000
KHRA-4315	3.15	15	30	70	4	14,000
KHRA-4316	3.16	15	30	70	4	14,000
KHRA-4317	3.17	15	30	70	4	14,000
KHRA-4318	3.18	15	30	70	4	14,000
KHRA-4319	3.19	15	30	70	4	14,000
KHRA-4320	3.2	15	30	70	4	12,700
KHRA-4321	3.21	15	30	70	4	14,000
KHRA-4322	3.22	15	30	70	4	14,000
KHRA-4323	3.23	15	30	70	4	14,000
KHRA-4324	3.24	15	30	70	4	14,000
KHRA-4325	3.25	15	30	70	4	14,000
KHRA-4326	3.26	15	30	70	4	14,000
KHRA-4327	3.27	15	30	70	4	14,000
KHRA-4328	3.28	15	30	70	4	14,000
KHRA-4329	3.29	15	30	70	4	14,000
KHRA-4330	3.3	15	30	70	4	12,700
KHRA-4331	3.31	15	30	70	4	14,000
KHRA-4332	3.32	15	30	70	4	14,000
KHRA-4333	3.33	15	30	70	4	14,000
KHRA-4334	3.34	15	30	70	4	14,000
KHRA-4335	3.35	15	30	70	4	14,000
KHRA-4336	3.36	15	30	70	4	14,000
KHRA-4337	3.37	15	30	70	4	14,000
KHRA-4338	3.38	15	30	70	4	14,000
KHRA-4339	3.39	15	30	70	4	14,000
KHRA-4340	3.4	15	30	70	4	12,700
KHRA-4341	3.41	15	30	70	4	14,000
KHRA-4342	3.42	15	30	70	4	14,000
KHRA-4343	3.43	15	30	70	4	14,000
KHRA-4344	3.44	15	30	70	4	14,000
KHRA-4345	3.45	15	30	70	4	14,000
KHRA-4346	3.46	15	30	70	4	14,000
KHRA-4347	3.47	15	30	70	4	14,000
KHRA-4348	3.48	15	30	70	4	14,000
KHRA-4349	3.49	15	30	70	4	14,000
KHRA-4350	3.5	15	30	70	4	12,700
KHRA-4351	3.51	15	30	70	4	14,000
KHRA-4352	3.52	15	30	70	4	14,000
KHRA-4353	3.53	15	30	70	4	14,000
KHRA-4354	3.54	15	30	70	4	14,000
KHRA-4355	3.55	15	30	70	4	14,000
KHRA-4356	3.56	15	30	70	4	14,000
KHRA-4357	3.57	15	30	70	4	14,000

品番 Code No.	刃径 D Flute Diameter	刃長 ℓ Flute Length	有効長 ℓ1 Effective Length	全長 L Total Length	柄径 d Shank Diameter	標準価格 Retail Price
KHRA-4358	3.58	15	30	70	4	14,000
KHRA-4359	3.59	15	30	70	4	14,000
KHRA-4360	3.6	15	30	70	4	12,700
KHRA-4361	3.61	15	30	70	4	14,000
KHRA-4362	3.62	15	30	70	4	14,000
KHRA-4363	3.63	15	30	70	4	14,000
KHRA-4364	3.64	15	30	70	4	14,000
KHRA-4365	3.65	15	30	70	4	14,000
KHRA-4366	3.66	15	30	70	4	14,000
KHRA-4367	3.67	15	30	70	4	14,000
KHRA-4368	3.68	15	30	70	4	14,000
KHRA-4369	3.69	15	30	70	4	14,000
KHRA-4370	3.7	15	30	70	4	12,700
KHRA-4371	3.71	15	30	70	4	14,000
KHRA-4372	3.72	15	30	70	4	14,000
KHRA-4373	3.73	15	30	70	4	14,000
KHRA-4374	3.74	15	30	70	4	14,000
KHRA-4375	3.75	15	30	70	4	14,000
KHRA-4376	3.76	15	30	70	4	14,000
KHRA-4377	3.77	15	30	70	4	14,000
KHRA-4378	3.78	15	30	70	4	14,000
KHRA-4379	3.79	15	30	70	4	14,000
KHRA-4380	3.8	15	30	70	4	12,700
KHRA-4381	3.81	15	30	70	4	14,000
KHRA-4382	3.82	15	30	70	4	14,000
KHRA-4383	3.83	15	30	70	4	14,000
KHRA-4384	3.84	15	30	70	4	14,000
KHRA-4385	3.85	15	30	70	4	14,000
KHRA-4386	3.86	15	30	70	4	14,000
KHRA-4387	3.87	15	30	70	4	14,000
KHRA-4388	3.88	15	30	70	4	14,000
KHRA-4389	3.89	15	30	70	4	14,000
KHRA-4390	3.9	15	30	70	4	12,700
KHRA-4391	3.91	20	35	70	4	14,700
KHRA-4392	3.92	20	35	70	4	14,700
KHRA-4393	3.93	20	35	70	4	14,700
KHRA-4394	3.94	20	35	70	4	14,700
KHRA-4395	3.95	20	35	70	4	14,700
KHRA-4396	3.96	20	35	70	4	14,700
KHRA-4397	3.97	20	35	70	4	14,700
KHRA-4398	3.98	20	35	70	4	14,700
KHRA-4399	3.99	20	35	70	4	14,700
KHRA-4400	4	20	35	70	4	13,400
KHRA-4401	4.01	20	35	70	4	14,700
KHRA-4402	4.02	20	35	70	4	14,700
KHRA-4403	4.03	20	35	70	4	14,700
KHRA-4404	4.04	20	35	70	4	14,700
KHRA-4405	4.05	20	35	70	4	14,700

超硬製品

Tungsten Carbide



# KHRA-4

品番 Code No.	刃径 D Flute Diameter	刃長 ℓ Flute Length	有効長 ℓ1 Effective Length	全長 L Total Length	柄径 d Shank Diameter	標準価格 Retail Price
KHRA-4406	4.06	20	35	70	4	14,700
KHRA-4407	4.07	20	35	70	4	14,700
KHRA-4408	4.08	20	35	70	4	14,700
KHRA-4409	4.09	20	35	70	4	14,700
KHRA-4410	4.1	20	35	80	6	14,300
KHRA-4411	4.11	20	35	80	6	15,700
KHRA-4412	4.12	20	35	80	6	15,700
KHRA-4413	4.13	20	35	80	6	15,700
KHRA-4414	4.14	20	35	80	6	15,700
KHRA-4415	4.15	20	35	80	6	15,700
KHRA-4416	4.16	20	35	80	6	15,700
KHRA-4417	4.17	20	35	80	6	15,700
KHRA-4418	4.18	20	35	80	6	15,700
KHRA-4419	4.19	20	35	80	6	15,700
KHRA-4420	4.2	20	35	80	6	14,300
KHRA-4421	4.21	20	35	80	6	15,700
KHRA-4422	4.22	20	35	80	6	15,700
KHRA-4423	4.23	20	35	80	6	15,700
KHRA-4424	4.24	20	35	80	6	15,700
KHRA-4425	4.25	20	35	80	6	15,700
KHRA-4426	4.26	20	35	80	6	15,700
KHRA-4427	4.27	20	35	80	6	15,700
KHRA-4428	4.28	20	35	80	6	15,700
KHRA-4429	4.29	20	35	80	6	15,700
KHRA-4430	4.3	20	35	80	6	14,300
KHRA-4431	4.31	20	35	80	6	15,700
KHRA-4432	4.32	20	35	80	6	15,700
KHRA-4433	4.33	20	35	80	6	15,700
KHRA-4434	4.34	20	35	80	6	15,700
KHRA-4435	4.35	20	35	80	6	15,700
KHRA-4436	4.36	20	35	80	6	15,700
KHRA-4437	4.37	20	35	80	6	15,700
KHRA-4438	4.38	20	35	80	6	15,700
KHRA-4439	4.39	20	35	80	6	15,700
KHRA-4440	4.4	20	35	80	6	14,300
KHRA-4441	4.41	20	35	80	6	15,700
KHRA-4442	4.42	20	35	80	6	15,700
KHRA-4443	4.43	20	35	80	6	15,700
KHRA-4444	4.44	20	35	80	6	15,700
KHRA-4445	4.45	20	35	80	6	15,700
KHRA-4446	4.46	20	35	80	6	15,700
KHRA-4447	4.47	20	35	80	6	15,700
KHRA-4448	4.48	20	35	80	6	15,700
KHRA-4449	4.49	20	35	80	6	15,700
KHRA-4450	4.5	20	35	80	6	14,300
KHRA-4451	4.51	20	35	80	6	15,700
KHRA-4452	4.52	20	35	80	6	15,700
KHRA-4453	4.53	20	35	80	6	15,700

品番 Code No.	刃径 D Flute Diameter	刃長 ℓ Flute Length	有効長 ℓ1 Effective Length	全長 L Total Length	柄径 d Shank Diameter	標準価格 Retail Price
KHRA-4454	4.54	20	35	80	6	15,700
KHRA-4455	4.55	20	35	80	6	15,700
KHRA-4456	4.56	20	35	80	6	15,700
KHRA-4457	4.57	20	35	80	6	15,700
KHRA-4458	4.58	20	35	80	6	15,700
KHRA-4459	4.59	20	35	80	6	15,700
KHRA-4460	4.6	20	35	80	6	14,300
KHRA-4461	4.61	20	35	80	6	15,700
KHRA-4462	4.62	20	35	80	6	15,700
KHRA-4463	4.63	20	35	80	6	15,700
KHRA-4464	4.64	20	35	80	6	15,700
KHRA-4465	4.65	20	35	80	6	15,700
KHRA-4466	4.66	20	35	80	6	15,700
KHRA-4467	4.67	20	35	80	6	15,700
KHRA-4468	4.68	20	35	80	6	15,700
KHRA-4469	4.69	20	35	80	6	15,700
KHRA-4470	4.7	20	35	80	6	14,300
KHRA-4471	4.71	20	35	80	6	15,700
KHRA-4472	4.72	20	35	80	6	15,700
KHRA-4473	4.73	20	35	80	6	15,700
KHRA-4474	4.74	20	35	80	6	15,700
KHRA-4475	4.75	20	35	80	6	15,700
KHRA-4476	4.76	20	35	80	6	15,700
KHRA-4477	4.77	20	35	80	6	15,700
KHRA-4478	4.78	20	35	80	6	15,700
KHRA-4479	4.79	20	35	80	6	15,700
KHRA-4480	4.8	20	35	80	6	14,300
KHRA-4481	4.81	20	35	80	6	15,700
KHRA-4482	4.82	20	35	80	6	15,700
KHRA-4483	4.83	20	35	80	6	15,700
KHRA-4484	4.84	20	35	80	6	15,700
KHRA-4485	4.85	20	35	80	6	15,700
KHRA-4486	4.86	20	35	80	6	15,700
KHRA-4487	4.87	20	35	80	6	15,700
KHRA-4488	4.88	20	35	80	6	15,700
KHRA-4489	4.89	20	35	80	6	15,700
KHRA-4490	4.9	20	35	80	6	14,300
KHRA-4491	4.91	24	40	80	6	16,400
KHRA-4492	4.92	24	40	80	6	16,400
KHRA-4493	4.93	24	40	80	6	16,400
KHRA-4494	4.94	24	40	80	6	16,400
KHRA-4495	4.95	24	40	80	6	16,400
KHRA-4496	4.96	24	40	80	6	16,400
KHRA-4497	4.97	24	40	80	6	16,400
KHRA-4498	4.98	24	40	80	6	16,400
KHRA-4499	4.99	24	40	80	6	16,400
KHRA-4500	5	24	40	80	6	15,000
KHRA-4501	5.01	24	40	80	6	16,400

# KHRA-4

品番 Code No.	刃径 D Flute Diameter	刃長 ℓ Flute Length	有効長 ℓ1 Effective Length	全長 L Total Length	柄径 d Shank Diameter	標準価格 Retail Price
KHRA-4502	5.02	24	40	80	6	16,400
KHRA-4503	5.03	24	40	80	6	16,400
KHRA-4504	5.04	24	40	80	6	16,400
KHRA-4505	5.05	24	40	80	6	16,400
KHRA-4506	5.06	24	40	80	6	16,400
KHRA-4507	5.07	24	40	80	6	16,400
KHRA-4508	5.08	24	40	80	6	16,400
KHRA-4509	5.09	24	40	80	6	16,400
KHRA-4510	5.1	24	40	80	6	15,000
KHRA-4511	5.11	24	40	80	6	16,400
KHRA-4512	5.12	24	40	80	6	16,400
KHRA-4513	5.13	24	40	80	6	16,400
KHRA-4514	5.14	24	40	80	6	16,400
KHRA-4515	5.15	24	40	80	6	16,400
KHRA-4516	5.16	24	40	80	6	16,400
KHRA-4517	5.17	24	40	80	6	16,400
KHRA-4518	5.18	24	40	80	6	16,400
KHRA-4519	5.19	24	40	80	6	16,400
KHRA-4520	5.2	24	40	80	6	15,000
KHRA-4521	5.21	24	40	80	6	16,400
KHRA-4522	5.22	24	40	80	6	16,400
KHRA-4523	5.23	24	40	80	6	16,400
KHRA-4524	5.24	24	40	80	6	16,400
KHRA-4525	5.25	24	40	80	6	16,400
KHRA-4526	5.26	24	40	80	6	16,400
KHRA-4527	5.27	24	40	80	6	16,400
KHRA-4528	5.28	24	40	80	6	16,400
KHRA-4529	5.29	24	40	80	6	16,400
KHRA-4530	5.3	24	40	80	6	15,000
KHRA-4531	5.31	24	40	80	6	16,400
KHRA-4532	5.32	24	40	80	6	16,400
KHRA-4533	5.33	24	40	80	6	16,400
KHRA-4534	5.34	24	40	80	6	16,400
KHRA-4535	5.35	24	40	80	6	16,400
KHRA-4536	5.36	24	40	80	6	16,400
KHRA-4537	5.37	24	40	80	6	16,400
KHRA-4538	5.38	24	40	80	6	16,400
KHRA-4539	5.39	24	40	80	6	16,400
KHRA-4540	5.4	24	40	80	6	15,000
KHRA-4541	5.41	24	40	80	6	16,400
KHRA-4542	5.42	24	40	80	6	16,400
KHRA-4543	5.43	24	40	80	6	16,400
KHRA-4544	5.44	24	40	80	6	16,400
KHRA-4545	5.45	24	40	80	6	16,400
KHRA-4546	5.46	24	40	80	6	16,400
KHRA-4547	5.47	24	40	80	6	16,400
KHRA-4548	5.48	24	40	80	6	16,400
KHRA-4549	5.49	24	40	80	6	16,400

品番 Code No.	刃径 D Flute Diameter	刃長 ℓ Flute Length	有効長 ℓ1 Effective Length	全長 L Total Length	柄径 d Shank Diameter	標準価格 Retail Price
KHRA-4550	5.5	24	40	80	6	15,000
KHRA-4551	5.51	24	40	80	6	16,400
KHRA-4552	5.52	24	40	80	6	16,400
KHRA-4553	5.53	24	40	80	6	16,400
KHRA-4554	5.54	24	40	80	6	16,400
KHRA-4555	5.55	24	40	80	6	16,400
KHRA-4556	5.56	24	40	80	6	16,400
KHRA-4557	5.57	24	40	80	6	16,400
KHRA-4558	5.58	24	40	80	6	16,400
KHRA-4559	5.59	24	40	80	6	16,400
KHRA-4560	5.6	24	40	80	6	15,000
KHRA-4561	5.61	24	40	80	6	16,400
KHRA-4562	5.62	24	40	80	6	16,400
KHRA-4563	5.63	24	40	80	6	16,400
KHRA-4564	5.64	24	40	80	6	16,400
KHRA-4565	5.65	24	40	80	6	16,400
KHRA-4566	5.66	24	40	80	6	16,400
KHRA-4567	5.67	24	40	80	6	16,400
KHRA-4568	5.68	24	40	80	6	16,400
KHRA-4569	5.69	24	40	80	6	16,400
KHRA-4570	5.7	24	40	80	6	15,000
KHRA-4571	5.71	24	40	80	6	16,400
KHRA-4572	5.72	24	40	80	6	16,400
KHRA-4573	5.73	24	40	80	6	16,400
KHRA-4574	5.74	24	40	80	6	16,400
KHRA-4575	5.75	24	40	80	6	16,400
KHRA-4576	5.76	24	40	80	6	16,400
KHRA-4577	5.77	24	40	80	6	16,400
KHRA-4578	5.78	24	40	80	6	16,400
KHRA-4579	5.79	24	40	80	6	16,400
KHRA-4580	5.8	24	40	80	6	15,000
KHRA-4581	5.81	24	40	80	6	16,400
KHRA-4582	5.82	24	40	80	6	16,400
KHRA-4583	5.83	24	40	80	6	16,400
KHRA-4584	5.84	24	40	80	6	16,400
KHRA-4585	5.85	24	40	80	6	16,400
KHRA-4586	5.86	24	40	80	6	16,400
KHRA-4587	5.87	24	40	80	6	16,400
KHRA-4588	5.88	24	40	80	6	16,400
KHRA-4589	5.89	24	40	80	6	16,400
KHRA-4590	5.9	24	40	80	6	15,000
KHRA-4591	5.91	24	40	80	6	16,400
KHRA-4592	5.92	24	40	80	6	16,400
KHRA-4593	5.93	24	40	80	6	16,400
KHRA-4594	5.94	24	40	80	6	16,400
KHRA-4595	5.95	24	40	80	6	16,400
KHRA-4596	5.96	24	40	80	6	16,400
KHRA-4597	5.97	24	40	80	6	16,400

超硬製品

Tungsten Carbide

# KHRA-4

品番 Code No.	刃径 D Flute Diameter	刃長 ℓ Flute Length	有効長 ℓ1 Effective Length	全長 L Total Length	柄径 d Shank Diameter	標準価格 Retail Price
KHRA-4598	5.98	24	40	80	6	16,400
KHRA-4599	5.99	24	40	80	6	16,400
KHRA-4600	6	24	40	80	6	15,000
KHRA-4601	6.01	24	40	80	6	16,400
KHRA-4602	6.02	24	40	80	6	16,400
KHRA-4603	6.03	24	40	80	6	16,400
KHRA-4604	6.04	24	40	80	6	16,400
KHRA-4605	6.05	24	40	80	6	16,400
KHRA-4610	6.1	25	45	100	8	22,000
KHRA-4615	6.15	25	45	100	8	23,900
KHRA-4620	6.2	25	45	100	8	22,000
KHRA-4625	6.25	25	45	100	8	23,900
KHRA-4630	6.3	25	45	100	8	22,000
KHRA-4635	6.35	25	45	100	8	23,900
KHRA-4640	6.4	25	45	100	8	22,000
KHRA-4645	6.45	25	45	100	8	23,900
KHRA-4650	6.5	25	45	100	8	22,000
KHRA-4655	6.55	25	45	100	8	23,900
KHRA-4660	6.6	25	45	100	8	22,000
KHRA-4665	6.65	25	45	100	8	23,900
KHRA-4670	6.7	25	45	100	8	22,000
KHRA-4675	6.75	25	45	100	8	23,900
KHRA-4680	6.8	25	45	100	8	22,000
KHRA-4685	6.85	25	45	100	8	23,900
KHRA-4690	6.9	25	45	100	8	22,000
KHRA-4695	6.95	25	45	100	8	23,900
KHRA-4696	6.96	25	45	100	8	23,900
KHRA-4697	6.97	25	45	100	8	23,900
KHRA-4698	6.98	25	45	100	8	23,900
KHRA-4699	6.99	25	45	100	8	23,900
KHRA-4700	7	25	45	100	8	22,000
KHRA-4701	7.01	25	45	100	8	23,900
KHRA-4702	7.02	25	45	100	8	23,900
KHRA-4703	7.03	25	45	100	8	23,900
KHRA-4704	7.04	25	45	100	8	23,900
KHRA-4705	7.05	25	45	100	8	23,900
KHRA-4710	7.1	25	45	100	8	22,000
KHRA-4715	7.15	25	45	100	8	23,900
KHRA-4720	7.2	25	45	100	8	22,000
KHRA-4725	7.25	25	45	100	8	23,900
KHRA-4730	7.3	25	45	100	8	22,000
KHRA-4735	7.35	25	45	100	8	23,900
KHRA-4740	7.4	25	45	100	8	22,000
KHRA-4745	7.45	25	45	100	8	23,900
KHRA-4750	7.5	25	45	100	8	22,000
KHRA-4755	7.55	25	45	100	8	23,900
KHRA-4760	7.6	25	45	100	8	22,000
KHRA-4765	7.65	25	45	100	8	23,900

品番 Code No.	刃径 D Flute Diameter	刃長 ℓ Flute Length	有効長 ℓ1 Effective Length	全長 L Total Length	柄径 d Shank Diameter	標準価格 Retail Price
KHRA-4770	7.7	25	45	100	8	22,000
KHRA-4775	7.75	25	45	100	8	23,900
KHRA-4780	7.8	25	45	100	8	22,000
KHRA-4785	7.85	25	45	100	8	23,900
KHRA-4790	7.9	25	45	100	8	22,000
KHRA-4795	7.95	25	45	100	8	23,900
KHRA-4796	7.96	25	45	100	8	23,900
KHRA-4797	7.97	25	45	100	8	23,900
KHRA-4798	7.98	25	45	100	8	23,900
KHRA-4799	7.99	25	45	100	8	23,900
KHRA-4800	8	25	45	100	8	22,000
KHRA-4801	8.01	25	45	100	8	23,900
KHRA-4802	8.02	25	45	100	8	23,900
KHRA-4803	8.03	25	45	100	8	23,900
KHRA-4804	8.04	25	45	100	8	23,900
KHRA-4805	8.05	25	45	100	8	23,900
KHRA-4810	8.1	25	50	100	10	27,000
KHRA-4815	8.15	25	50	100	10	29,400
KHRA-4820	8.2	25	50	100	10	27,000
KHRA-4825	8.25	25	50	100	10	29,400
KHRA-4830	8.3	25	50	100	10	27,000
KHRA-4835	8.35	25	50	100	10	29,400
KHRA-4840	8.4	25	50	100	10	27,000
KHRA-4845	8.45	25	50	100	10	29,400
KHRA-4850	8.5	25	50	100	10	27,000
KHRA-4855	8.55	25	50	100	10	29,400
KHRA-4860	8.6	25	50	100	10	27,000
KHRA-4865	8.65	25	50	100	10	29,400
KHRA-4870	8.7	25	50	100	10	27,000
KHRA-4875	8.75	25	50	100	10	29,400
KHRA-4880	8.8	25	50	100	10	27,000
KHRA-4885	8.85	25	50	100	10	29,400
KHRA-4890	8.9	25	50	100	10	27,000
KHRA-4895	8.95	25	50	100	10	29,400
KHRA-4896	8.96	25	50	100	10	27,000
KHRA-4897	8.97	25	50	100	10	29,400
KHRA-4898	8.98	25	50	100	10	27,000
KHRA-4899	8.99	25	50	100	10	29,400
KHRA-4900	9	25	50	100	10	27,000
KHRA-4901	9.01	25	50	100	10	29,400
KHRA-4902	9.02	25	50	100	10	29,400
KHRA-4903	9.03	25	50	100	10	29,400
KHRA-4904	9.04	25	50	100	10	29,400
KHRA-4905	9.05	25	50	100	10	29,400
KHRA-4910	9.1	25	50	100	10	27,000
KHRA-4915	9.15	25	50	100	10	29,400
KHRA-4920	9.2	25	50	100	10	29,400
KHRA-4925	9.25	25	50	100	10	29,400



# KSHR-4

超硬スパイラルリーマ  
Tungsten Carbide 4 Flutes Spiral Reamer

■小径穴仕上加工用Φ0.5~Φ2.03まで0.01とびにラインナップ  
Line-upped Φ0.5~Φ2.03 at pitch 0.01



超微粒子合金 Micro Grain Tungsten Carbide



刃径の許容差 Flute Diameter Tolerance  
D +0.002~+0.005



柄径の許容差 Shank Diameter Tolerance  
d 0~-0.006



左ネジレ右刃 ネジレ角30°  
Left Twist Right Flute Twist Angle 30°



喰付角片角2° Chamfer Angle Single 2°

●切削条件表はP228に記載  
●Cutting conditions are recommended on page 228.

単位[寸法:mm/価格:円]

Unit [size:mm/Retail Price:JPY]

品番 Code No.	刃径 D Flute Diameter	刃長 ℓ Flute Length	有効長ℓ1 Effective Length	全長 L Total Length	柄径 d Shank Diameter	喰付長ℓ2 Chamfer Length	標準価格 Retail Price
KSHR-4050	0.5	8	13	60	3	1.2	8,000
KSHR-4051	0.51	8	13	60	3	1.2	9,000
KSHR-4052	0.52	8	13	60	3	1.2	9,000
KSHR-4053	0.53	8	13	60	3	1.2	9,000
KSHR-4054	0.54	8	13	60	3	1.2	9,000
KSHR-4055	0.55	8	13	60	3	1.2	9,000
KSHR-4056	0.56	8	13	60	3	1.2	9,000
KSHR-4057	0.57	8	13	60	3	1.2	9,000
KSHR-4058	0.58	8	13	60	3	1.2	9,000
KSHR-4059	0.59	8	13	60	3	1.2	9,000
KSHR-4060	0.6	8	13	60	3	1.5	7,500
KSHR-4061	0.61	8	13	60	3	1.5	8,000
KSHR-4062	0.62	8	13	60	3	1.5	8,000
KSHR-4063	0.63	8	13	60	3	1.5	8,000
KSHR-4064	0.64	8	13	60	3	1.5	8,000
KSHR-4065	0.65	8	13	60	3	1.5	8,000
KSHR-4066	0.66	8	13	60	3	1.5	8,000
KSHR-4067	0.67	8	13	60	3	1.5	8,000
KSHR-4068	0.68	8	13	60	3	1.5	8,000
KSHR-4069	0.69	8	13	60	3	1.5	8,000
KSHR-4070	0.7	8	13	60	3	2	6,600
KSHR-4071	0.71	8	13	60	3	2	7,200

品番 Code No.	刃径 D Flute Diameter	刃長 ℓ Flute Length	有効長ℓ1 Effective Length	全長 L Total Length	柄径 d Shank Diameter	喰付長ℓ2 Chamfer Length	標準価格 Retail Price
KSHR-4072	0.72	8	13	60	3	2	7,200
KSHR-4073	0.73	8	13	60	3	2	7,200
KSHR-4074	0.74	8	13	60	3	2	7,200
KSHR-4075	0.75	8	13	60	3	2	7,200
KSHR-4076	0.76	8	13	60	3	2	7,200
KSHR-4077	0.77	8	13	60	3	2	7,200
KSHR-4078	0.78	8	13	60	3	2	7,200
KSHR-4079	0.79	8	13	60	3	2	7,200
KSHR-4080	0.8	8	16	60	3	2	6,300
KSHR-4081	0.81	8	16	60	3	2	6,600
KSHR-4082	0.82	8	16	60	3	2	6,600
KSHR-4083	0.83	8	16	60	3	2	6,600
KSHR-4084	0.84	8	16	60	3	2	6,600
KSHR-4085	0.85	8	16	60	3	2	6,600
KSHR-4086	0.86	8	16	60	3	2	6,600
KSHR-4087	0.87	8	16	60	3	2	6,600
KSHR-4088	0.88	8	16	60	3	2	6,600
KSHR-4089	0.89	8	16	60	3	2	6,600
KSHR-4090	0.9	8	16	60	3	2	6,100
KSHR-4091	0.91	8	16	60	3	2	6,300
KSHR-4092	0.92	8	16	60	3	2	6,300
KSHR-4093	0.93	8	16	60	3	2	6,300
KSHR-4094	0.94	8	16	60	3	2	6,300
KSHR-4095	0.95	8	16	60	3	2	6,300
KSHR-4096	0.96	8	16	60	3	2	6,300
KSHR-4097	0.97	8	16	60	3	2	6,300
KSHR-4098	0.98	8	16	60	3	2	6,300
KSHR-4099	0.99	8	16	60	3	2	6,300
KSHR-4100	1	8	16	60	3	2.5	5,300
KSHR-4101	1.01	10	16	60	3	2.5	6,100
KSHR-4102	1.02	10	16	60	3	2.5	6,100
KSHR-4103	1.03	10	16	60	3	2.5	6,100
KSHR-4104	1.04	10	16	60	3	2.5	6,100
KSHR-4105	1.05	10	16	60	3	2.5	6,100
KSHR-4106	1.06	10	16	60	3	2.5	6,100
KSHR-4107	1.07	10	16	60	3	2.5	6,100
KSHR-4108	1.08	10	16	60	3	2.5	6,100
KSHR-4109	1.09	10	16	60	3	2.5	6,100
KSHR-4110	1.1	10	16	60	3	2.5	5,300
KSHR-4111	1.11	10	16	60	3	2.5	6,100
KSHR-4112	1.12	10	16	60	3	2.5	6,100
KSHR-4113	1.13	10	16	60	3	2.5	6,100
KSHR-4114	1.14	10	16	60	3	2.5	6,100
KSHR-4115	1.15	10	16	60	3	2.5	6,100
KSHR-4116	1.16	10	16	60	3	2.5	6,100
KSHR-4117	1.17	10	16	60	3	2.5	6,100
KSHR-4118	1.18	10	16	60	3	2.5	6,100
KSHR-4119	1.19	10	16	60	3	2.5	6,100

