

# CBNボールエンドミル ショートシャンク

# アタックスミス CBNボールエンドミル

## YBBES形

φ4シャンク  
直刃  
電界砥粒制御研磨

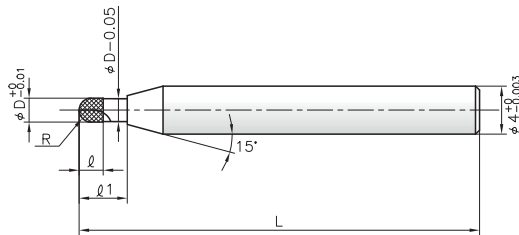

## BBEF形

φ4シャンク  
直刃  
電界砥粒制御研磨

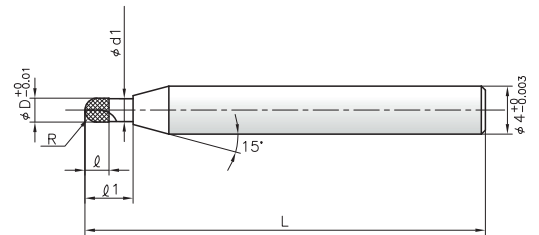

●切削条件 P.68

型番	ツールNo.	R	刃径 D	刃長 ℓ	有効長 ℓ1	全長 L	刃数	価格
YBBES-1005	KY21389	0.05	0.1	0.3	0.3	35	1	100,000
YBBES-1010	KY21390	0.1	0.2	0.3	0.6	35	1	37,500
YBBES-2015	KY21391	0.15	0.3	0.3	1	35	2	37,500
YBBES-2020	KY21392	0.2	0.4	0.5	1.5	35	2	30,500
YBBES-2025	KY21393	0.25	0.5	0.5	1.5	35	2	30,500
YBBES-2030	KY21394	0.3	0.6	0.6	2	35	2	30,500
YBBES-2040	KY21395	0.4	0.8	0.8	2.5	35	2	30,500
YBBES-2050	KY21396	0.5	1	1	3	40	2	23,500
YBBES-2060	KY21397	0.6	1.2	1.2	4	40	2	34,500
YBBES-2070	KY21398	0.7	1.4	1.2	4.5	40	2	34,500
YBBES-2075	KY21399	0.75	1.5	1.2	4.5	40	2	34,500
YBBES-2080	KY21400	0.8	1.6	1.2	5	40	2	34,500
YBBES-2090	KY21401	0.9	1.8	1.5	5.5	40	2	34,500
YBBES-2100	KY21402	1	2	1.5	6	40	2	26,250
YBBES-2150	KY21403	1.5	3	2	9	40	2	44,500

●切削条件 P.68

型番	ツールNo.	R	刃径 D	刃長 ℓ	首下径 d1	有効長 ℓ1	全長 L	刃数	価格
BBEF-2010006	KY21692	0.1	0.2	0.2	0.18	0.6	50	1	20,800
BBEF-2010012	KY21693	0.1	0.2	0.2	0.18	1.2	50	1	21,200
BBEF-2015009	KY21694	0.15	0.3	0.3	0.28	0.9	50	2	20,300
BBEF-2015018	KY21695	0.15	0.3	0.3	0.28	1.8	50	2	20,800
BBEF-2020012	KY21696	0.2	0.4	0.4	0.37	1.2	50	2	19,100
BBEF-2020024	KY21697	0.2	0.4	0.4	0.37	2.4	50	2	19,600
BBEF-2025015	KY21698	0.25	0.5	0.5	0.46	1.5	50	2	18,700
BBEF-2025030	KY21699	0.25	0.5	0.5	0.46	3	50	2	19,100
BBEF-2030018	KY21700	0.3	0.6	0.6	0.56	1.8	50	2	17,400
BBEF-2030036	KY21701	0.3	0.6	0.6	0.56	3.6	50	2	17,900
BBEF-2040024	KY21702	0.4	0.8	0.8	0.76	2.4	50	2	17,400
BBEF-2040048	KY21703	0.4	0.8	0.8	0.76	4.8	50	2	17,900
BBEF-2050030	KY21704	0.5	1	1	0.95	3	50	2	17,000
BBEF-2050060	KY21705	0.5	1	1	0.95	6	50	2	17,400
BBEF-2060036	KY22345	0.6	1.2	1.2	1.15	3.6	50	2	17,900
BBEF-2060072	KY22346	0.6	1.2	1.2	1.15	7.2	50	2	18,400
BBEF-2070042	KY22347	0.7	1.4	1.4	1.35	4.2	50	2	17,900
BBEF-2070084	KY22348	0.7	1.4	1.4	1.35	8.4	50	2	18,400
BBEF-2075045	KY21706	0.75	1.5	1.5	1.45	4.5	50	2	17,900
BBEF-2075090	KY21707	0.75	1.5	1.5	1.45	9	50	2	18,400
BBEF-2080048	KY22349	0.8	1.6	1.5	1.55	4.8	50	2	18,400
BBEF-2080096	KY22350	0.8	1.6	1.5	1.55	9.6	50	2	18,700
BBEF-2090054	KY22351	0.9	1.8	1.5	1.75	5.4	50	2	18,400
BBEF-2090108	KY22352	0.9	1.8	1.5	1.75	10.8	50	2	18,700
BBEF-2100060	KY21708	1	2	1.5	1.95	6	50	2	18,400
BBEF-2100120	KY21709	1	2	1.5	1.95	12	50	2	18,700
BBEF-2150090	KY21710	1.5	3	2	2.95	9	50	2	29,500
BBEF-2150180	KY21711	1.5	3	2	2.95	18	60	2	30,600

## 【電界砥粒制御研磨技術】 (特許取得：2007年1月)

工具の刃先研磨に機能性流体を適用し、砥石加工痕を除去して、刃先を滑らかに仕上げることで工具寿命を延ばすことに成功しました。

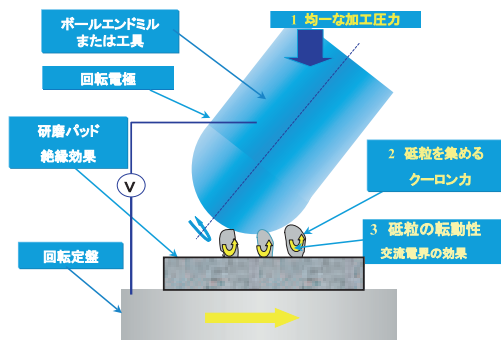

加工メカニズム

秋田県産業技術総合研究センター様 提供

# CBNテーパネック ボールエンドミル



## YBBETN形

2枚刃  
直刃  
電界砥粒制御研磨

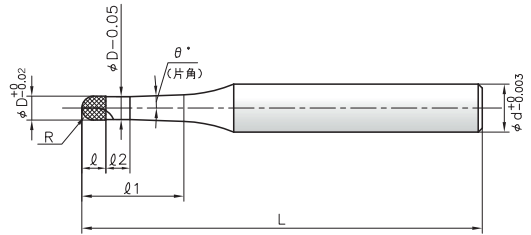

●切削条件 P.68

型番	ツールNo.	R	刃径 D	刃長 ℓ	有効長 ℓ1	首勾配角 θ°	全長 L	柄径 d	価格
YBBETN-202002-05	KY21449	0.2	0.4	0.5	2	30'	40	4	48,000
YBBETN-202002-10	KY21450	0.2	0.4	0.5	2	1°	40	4	48,000
YBBETN-202002-20	KY21451	0.2	0.4	0.5	2	2°	40	4	48,000
YBBETN-202004-05	KY21452	0.2	0.4	0.5	4	30'	40	4	54,670
YBBETN-202004-10	KY21453	0.2	0.4	0.5	4	1°	40	4	54,670
YBBETN-202004-20	KY21454	0.2	0.4	0.5	4	2°	40	4	54,670
YBBETN-202502-05	KY21455	0.25	0.5	0.5	2	30'	40	4	48,000
YBBETN-202502-10	KY21456	0.25	0.5	0.5	2	1°	40	4	48,000
YBBETN-202502-20	KY21457	0.25	0.5	0.5	2	2°	40	4	48,000
YBBETN-202504-05	KY21458	0.25	0.5	0.5	4	30'	40	4	54,670
YBBETN-202504-10	KY21459	0.25	0.5	0.5	4	1°	40	4	54,670
YBBETN-202504-20	KY21460	0.25	0.5	0.5	4	2°	40	4	54,670
YBBETN-203002-05	KY21461	0.3	0.6	0.6	2	30'	40	4	48,000
YBBETN-203002-10	KY21462	0.3	0.6	0.6	2	1°	40	4	48,000
YBBETN-203002-20	KY21463	0.3	0.6	0.6	2	2°	40	4	48,000
YBBETN-203004-05	KY21464	0.3	0.6	0.6	4	30'	40	4	54,670
YBBETN-203004-10	KY21465	0.3	0.6	0.6	4	1°	40	4	54,670
YBBETN-203004-20	KY21466	0.3	0.6	0.6	4	2°	40	4	54,670
YBBETN-204004-05	KY21467	0.4	0.8	0.8	4	30'	40	4	48,000
YBBETN-204004-10	KY21468	0.4	0.8	0.8	4	1°	40	4	48,000
YBBETN-204004-20	KY21469	0.4	0.8	0.8	4	2°	40	4	48,000
YBBETN-204006-05	KY21470	0.4	0.8	0.8	6	30'	40	4	54,670
YBBETN-204006-10	KY21471	0.4	0.8	0.8	6	1°	40	4	54,670
YBBETN-204006-20	KY21472	0.4	0.8	0.8	6	2°	40	4	54,670
YBBETN-205006-05	KY21473	0.5	1	1	6	30'	50	4	44,000
YBBETN-205006-10	KY21474	0.5	1	1	6	1°	50	4	44,000
YBBETN-205006-20	KY21475	0.5	1	1	6	2°	50	4	44,000
YBBETN-205008-05	KY21476	0.5	1	1	8	30'	50	4	50,000
YBBETN-205008-10	KY21477	0.5	1	1	8	1°	50	4	50,000
YBBETN-205008-20	KY21478	0.5	1	1	8	2°	50	4	50,000
YBBETN-205010-05	KY21479	0.5	1	1	10	30'	50	4	60,670
YBBETN-205010-10	KY21480	0.5	1	1	10	1°	50	4	60,670
YBBETN-205010-20	KY21481	0.5	1	1	10	2°	50	4	60,670
YBBETN-206006-05	KY21482	0.6	1.2	1.2	6	30'	50	4	54,000
YBBETN-206006-10	KY21483	0.6	1.2	1.2	6	1°	50	4	54,000
YBBETN-206006-20	KY21484	0.6	1.2	1.2	6	2°	50	4	54,000
YBBETN-206008-05	KY21485	0.6	1.2	1.2	8	30'	50	4	61,670
YBBETN-206008-10	KY21486	0.6	1.2	1.2	8	1°	50	4	61,670
YBBETN-206008-20	KY21487	0.6	1.2	1.2	8	2°	50	4	61,670
YBBETN-207006-05	KY21488	0.7	1.4	1.2	6	30'	50	4	54,000
YBBETN-207006-10	KY21489	0.7	1.4	1.2	6	1°	50	4	54,000
YBBETN-207006-20	KY21490	0.7	1.4	1.2	6	2°	50	4	54,000
YBBETN-207008-05	KY21491	0.7	1.4	1.2	8	30'	50	4	61,670
YBBETN-207008-10	KY21492	0.7	1.4	1.2	8	1°	50	4	61,670
YBBETN-207008-20	KY21493	0.7	1.4	1.2	8	2°	50	4	61,670
YBBETN-208006-05	KY21494	0.8	1.6	1.2	6	30'	50	4	54,000
YBBETN-208006-10	KY21495	0.8	1.6	1.2	6	1°	50	4	54,000
YBBETN-208006-20	KY21496	0.8	1.6	1.2	6	2°	50	4	54,000
YBBETN-208008-05	KY21497	0.8	1.6	1.2	8	30'	50	4	61,670
YBBETN-208008-10	KY21498	0.8	1.6	1.2	8	1°	50	4	61,670

型番	ツールNo.	R	刃径 D	刃長 ℓ	有効長 ℓ1	首勾配角 θ°	全長 L	柄径 d	価格
YBBETN-208008-20	KY21499	0.8	1.6	1.2	8	2°	50	4	61,670
YBBETN-209006-05	KY21500	0.9	1.8	1.5	6	30'	50	4	54,000
YBBETN-209006-10	KY21501	0.9	1.8	1.5	6	1°	50	4	54,000
YBBETN-209006-20	KY21502	0.9	1.8	1.5	6	2°	50	4	54,000
YBBETN-209008-05	KY21503	0.9	1.8	1.5	8	30'	50	4	61,670
YBBETN-209008-10	KY21504	0.9	1.8	1.5	8	1°	50	4	61,670
YBBETN-209008-20	KY21505	0.9	1.8	1.5	8	2°	50	4	61,670
YBBETN-210008-05	KY21506	1	2	1.5	8	30'	50	4	47,340
YBBETN-210008-10	KY21507	1	2	1.5	8	1°	50	4	47,340
YBBETN-210008-20	KY21508	1	2	1.5	8	2°	50	4	47,340
YBBETN-210010-05	KY21509	1	2	1.5	10	30'	50	4	58,340
YBBETN-210010-10	KY21510	1	2	1.5	10	1°	50	4	58,340
YBBETN-210010-20	KY21511	1	2	1.5	10	2°	50	4	58,340
YBBETN-210012-05	KY21512	1	2	1.5	12	30'	50	4	65,000
YBBETN-210012-10	KY21513	1	2	1.5	12	1°	50	4	65,000
YBBETN-210012-20	KY21514	1	2	1.5	12	2°	50	4	65,000
YBBETN-215012-05	KY21515	1.5	3	2	12	30'	60	6	68,670
YBBETN-215012-10	KY21516	1.5	3	2	12	1°	60	6	68,670
YBBETN-215012-20	KY21517	1.5	3	2	12	2°	60	6	68,670
YBBETN-215014-05	KY21518	1.5	3	2	14	30'	60	6	78,340
YBBETN-215014-10	KY21519	1.5	3	2	14	1°	60	6	78,340
YBBETN-215014-20	KY21520	1.5	3	2	14	2°	60	6	78,340
YBBETN-215016-05	KY21521	1.5	3	2	16	30'	60	6	94,670
YBBETN-215016-10	KY21522	1.5	3	2	16	1°	60	6	94,670
YBBETN-215016-20	KY21523	1.5	3	2	16	2°	60	6	94,670

## アタックスミス CBNボールエンドミル

### BBE形

φ6シャンク  
直刃  
電界砥粒制御研磨

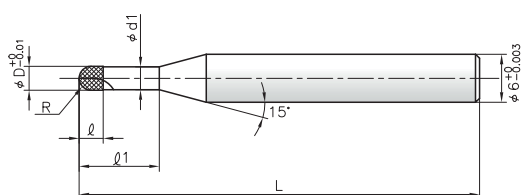

## アタックスミス CBNスパイラルボールエンドミル

### SBBEF形

φ4シャンク  
2枚刃  
スパイラル刃  
電界砥粒制御研磨

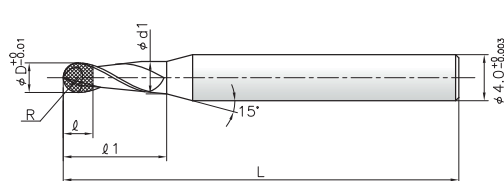

●切削条件 P.68

型番	ツールNo.	R	刃径 D	刃長 ℓ	首下径 d1	有効長 ℓ1	全長 L	刃数	価格
BBE-2010S	KY21429	0.1	0.2	0.2	0.18	0.6	50	1	21,200
BBE-2015S	KY21430	0.15	0.3	0.3	0.28	0.9	50	2	20,800
BBE-2020S	KY21431	0.2	0.4	0.5	0.37	1.2	50	2	19,600
BBE-2025S	KY21432	0.25	0.5	0.5	0.46	1.5	50	2	19,300
BBE-2030S	KY21433	0.3	0.6	0.6	0.56	1.8	50	2	17,900
BBE-2040S	KY21434	0.4	0.8	0.8	0.76	2.4	50	2	17,900
BBE-2050S	KY21435	0.5	1	1	0.95	3	50	2	17,400
BBE-2060S	KY22328	0.6	1.2	1.2	1.15	3.6	50	2	18,400
BBE-2070S	KY22329	0.7	1.4	1.4	1.35	4.2	50	2	18,400
BBE-2075S	KY21436	0.75	1.5	1.5	1.45	4.5	50	2	18,400
BBE-2080S	KY22330	0.8	1.6	1.5	1.55	4.8	50	2	18,700
BBE-2090S	KY22331	0.9	1.8	1.5	1.75	5.4	50	2	18,700
BBE-2100S	KY21437	1	2	1.5	1.95	6	50	2	18,700
BBE-2150S	KY21438	1.5	3	2	2.95	9	50	2	30,800
BBE-2200S	KY22332	2	4	2.5	3.95	12	50	2	45,300
BBE-2250S	KY22333	2.5	5	3	4.95	15	60	2	54,300
BBE-2300S	KY22334	3	6	3.5	5.95	20	60	2	60,800

●切削条件 P.67

型番	ツールNo.	R	刃径 D	刃長 ℓ	首下径 d1	有効長 ℓ1	全長 L	刃数	価格
SBBEF-2010006	KY22397	0.1	0.2	0.2	0.18	0.6	50	2	25,000
SBBEF-2010012	KY22398	0.1	0.2	0.2	0.18	1.2	50	2	25,500
SBBEF-2015009	KY22399	0.15	0.3	0.3	0.28	0.9	50	2	24,300
SBBEF-2015018	KY22400	0.15	0.3	0.3	0.28	1.8	50	2	25,000
SBBEF-2020012	KY22401	0.2	0.4	0.4	0.37	1.2	50	2	23,100
SBBEF-2020024	KY22402	0.2	0.4	0.4	0.37	2.4	50	2	23,600
SBBEF-2025015	KY22403	0.25	0.5	0.5	0.46	1.5	50	2	22,400
SBBEF-2025030	KY22404	0.25	0.5	0.5	0.46	3	50	2	23,100
SBBEF-2030018	KY22405	0.3	0.6	0.6	0.56	1.8	50	2	21,000
SBBEF-2030036	KY22406	0.3	0.6	0.6	0.56	3.6	50	2	21,500
SBBEF-2040024	KY22407	0.4	0.8	0.8	0.76	2.4	50	2	21,000
SBBEF-2040048	KY22408	0.4	0.8	0.8	0.76	4.8	50	2	21,500
SBBEF-2050030	KY22409	0.5	1	1	0.95	3	50	2	20,500
SBBEF-2050040	KY22410	0.5	1	1	0.95	4	50	2	21,000
SBBEF-2050050	KY22411	0.5	1	1	0.95	5	50	2	21,000
SBBEF-2050060	KY22412	0.5	1	1	0.95	6	50	2	21,000
SBBEF-2050080	KY22413	0.5	1	1	0.95	8	50	2	23,100
SBBEF-2050100	KY22414	0.5	1	1	0.95	10	50	2	24,100
SBBEF-2060036	KY22415	0.6	1.2	1.2	1.15	3.6	50	2	21,500
SBBEF-2060072	KY22416	0.6	1.2	1.2	1.15	7.2	50	2	22,000
SBBEF-2070042	KY22417	0.7	1.4	1.4	1.35	4.2	50	2	21,500
SBBEF-2070084	KY22418	0.7	1.4	1.4	1.35	8.4	50	2	22,000
SBBEF-2075045	KY22419	0.75	1.5	1.5	1.45	4.5	50	2	21,500
SBBEF-2075090	KY22420	0.75	1.5	1.5	1.45	9	50	2	22,000
SBBEF-2080048	KY22421	0.8	1.6	1.5	1.55	4.8	50	2	22,000
SBBEF-2080096	KY22422	0.8	1.6	1.5	1.55	9.6	50	2	22,400
SBBEF-2090054	KY22423	0.9	1.8	1.5	1.75	5.4	50	2	22,000
SBBEF-2090108	KY22424	0.9	1.8	1.5	1.75	10.8	50	2	22,400
SBBEF-2100060	KY22425	1	2	1.5	1.95	6	50	2	22,000
SBBEF-2100120	KY22426	1	2	1.5	1.95	12	50	2	22,400
SBBEF-2150090	KY22427	1.5	3	2	2.95	9	50	2	35,400
SBBEF-2150180	KY22428	1.5	3	2	2.95	18	60	2	36,700

## アタックスミス CBNスパイラルボールエンドミル

### SBBE-2形

φ6シャンク  
2枚刃  
スパイラル刃  
電界砥粒制御研磨

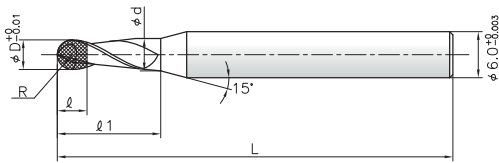

●切削条件 P.67

型番	ツールNo.	R	刃径 D	刃長 ℓ	首下径 d1	有効長 ℓ1	全長 L	価格
SBBE-2010	KY22353	0.1	0.2	0.2	0.18	0.6	50	25,500
SBBE-2015	KY22354	0.15	0.3	0.3	0.28	0.9	50	25,000
SBBE-2020	KY22355	0.2	0.4	0.4	0.37	1.2	50	23,600
SBBE-2025	KY22356	0.25	0.5	0.5	0.46	1.5	50	23,100
SBBE-2030	KY22357	0.3	0.6	0.6	0.56	1.8	50	21,500
SBBE-2040	KY22358	0.4	0.8	0.8	0.76	2.4	50	21,500
SBBE-2050	KY22359	0.5	1	1	0.95	3	50	21,000
SBBE-2060	KY22360	0.6	1.2	1.2	1.15	3.6	50	22,100
SBBE-2070	KY22361	0.7	1.4	1.4	1.35	4.2	50	22,100
SBBE-2075	KY22362	0.75	1.5	1.5	1.45	4.5	50	22,100
SBBE-2080	KY22363	0.8	1.6	1.5	1.55	4.8	50	22,700
SBBE-2090	KY22364	0.9	1.8	1.5	1.75	5.4	50	22,700
SBBE-2100	KY22365	1	2	1.5	1.95	6	50	22,700
SBBE-2150	KY22366	1.5	3	2	2.95	9	50	36,700
SBBE-2200	KY22367	2	4	2.5	3.95	12	50	54,300
SBBE-2250	KY22368	2.5	5	3	4.95	15	60	65,500
SBBE-2300	KY22369	3	6	3.5	5.95	20	60	72,900

## アタックスミス CBNスパイラルボールエンドミル

### SBBE-3形

φ6シャンク  
3枚刃  
スパイラル刃  
電界砥粒制御研磨

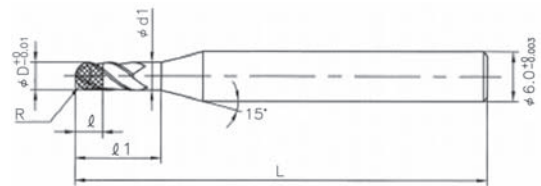

●切削条件 P.67

型番	ツールNo.	R	刃径 D	刃長 ℓ	首下径 d1	有効長 ℓ1	全長 L	価格
SBBE-3050	KY22586	0.5	1	1	0.95	2	50	27,000
SBBE-3075	KY22587	0.75	1.5	1.5	1.45	3	50	28,500
SBBE-3100	KY22588	1	2	1.5	1.95	4	50	30,000
SBBE-3150	KY22589	1.5	3	2	2.95	6	50	47,000

# CBNコーナーR付エンドミル ショートシャンク

## YBRES形

φ4シャンク  
2枚刃  
直刃  
電界砥粒制御研磨

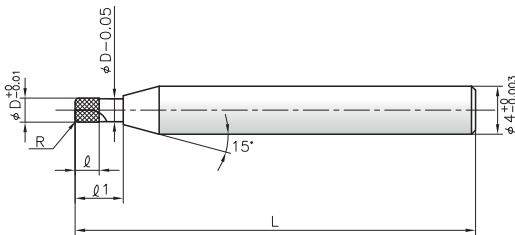

●切削条件 P.68

型番	ツールNo.	刃径 D	コーナー R	刃長 ℓ	有効長 ℓ1	全長 L	価格
YBRES-203005	KY21644	0.3	0.05	0.3	0.9	35	48,340
YBRES-203010	KY21645	0.3	0.1	0.3	0.9	35	48,340
YBRES-204005	KY21646	0.4	0.05	0.5	1.2	35	40,000
YBRES-204010	KY21647	0.4	0.1	0.5	1.2	35	40,000
YBRES-205010	KY21404	0.5	0.1	0.5	1.5	35	32,000
YBRES-205020	KY21405	0.5	0.2	0.5	1.5	35	32,000
YBRES-206010	KY21406	0.6	0.1	0.6	2	35	36,670
YBRES-206020	KY21407	0.6	0.2	0.6	2	35	36,670
YBRES-207010	KY21408	0.7	0.1	0.7	2	35	36,670
YBRES-207020	KY21409	0.7	0.2	0.7	2	35	36,670
YBRES-208010	KY21410	0.8	0.1	0.8	2.5	35	36,670
YBRES-208020	KY21411	0.8	0.2	0.8	2.5	35	36,670
YBRES-209010	KY21412	0.9	0.1	1	3	35	36,670
YBRES-209020	KY21413	0.9	0.2	1	3	35	36,670
YBRES-210010	KY21414	1	0.1	1	3	40	28,340
YBRES-210020	KY21415	1	0.2	1	3	40	34,000
YBRES-210030	KY21416	1	0.3	1	3	40	34,000
YBRES-215010	KY21417	1.5	0.1	1.5	4.5	40	34,000
YBRES-215020	KY21418	1.5	0.2	1.5	4.5	40	38,670
YBRES-215030	KY21419	1.5	0.3	1.5	4.5	40	38,670
YBRES-215050	KY21420	1.5	0.5	1.5	4.5	40	38,670
YBRES-220010	KY21421	2	0.1	1.5	6	40	42,670
YBRES-220020	KY21422	2	0.2	1.5	6	40	36,000
YBRES-220030	KY21423	2	0.3	1.5	6	40	42,670
YBRES-220050	KY21424	2	0.5	1.5	6	40	42,670
YBRES-230010	KY21425	3	0.1	2	9	40	50,000
YBRES-230020	KY21426	3	0.2	2	9	40	50,000
YBRES-230030	KY21427	3	0.3	2	9	40	50,000
YBRES-230050	KY21428	3	0.5	2	9	40	50,000



# アタックスミス CBNコーナーR付エンドミル

## BREF-2形

φ4シャンク  
2枚刃  
直刃  
電界砥粒制御研磨

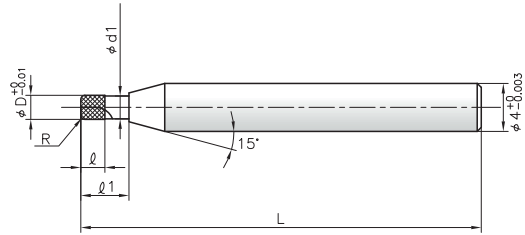

●切削条件 P.68

型番	ツールNo.	刃径 D	コーナー R	刃長 ℓ	首下径 d1	有効長 ℓ1	全長 L	価格
BREF-203003005	KY22622	0.3	0.03	0.3	0.26	0.5	50	21,500
BREF-203003009	KY22335	0.3	0.03	0.3	0.26	0.9	50	21,500
BREF-203003018	KY22336	0.3	0.03	0.3	0.26	1.8	50	22,000
BREF-203005005	KY22623	0.3	0.05	0.3	0.26	0.5	50	21,500
BREF-203005009	KY22337	0.3	0.05	0.3	0.26	0.9	50	21,500
BREF-203005018	KY22338	0.3	0.05	0.3	0.26	1.8	50	22,000
BREF-204003005	KY22624	0.4	0.03	0.4	0.36	0.5	50	20,000
BREF-204003012	KY22339	0.4	0.03	0.4	0.36	1.2	50	20,000
BREF-204003024	KY22340	0.4	0.03	0.4	0.36	2.4	50	20,600
BREF-204005005	KY22625	0.4	0.05	0.4	0.36	0.5	50	20,000
BREF-204005012	KY22341	0.4	0.05	0.4	0.36	1.2	50	20,000
BREF-204005024	KY22342	0.4	0.05	0.4	0.36	2.4	50	20,600
BREF-204010005	KY22626	0.4	0.1	0.4	0.36	0.5	50	20,000
BREF-204010012	KY22343	0.4	0.1	0.4	0.36	1.2	50	20,000
BREF-204010024	KY22344	0.4	0.1	0.4	0.36	2.4	50	20,600
BREF-205003005	KY22627	0.5	0.03	0.5	—	0.5	50	19,100
BREF-205003010	KY22628	0.5	0.03	0.5	0.46	1	50	19,600
BREF-205003015	KY21648	0.5	0.03	0.5	0.46	1.5	50	19,600
BREF-205003020	KY22629	0.5	0.03	0.5	0.46	2	50	20,300
BREF-205003030	KY21649	0.5	0.03	0.5	0.46	3	50	20,300
BREF-205005005	KY22630	0.5	0.05	0.5	—	0.5	50	19,100
BREF-205005010	KY22631	0.5	0.05	0.5	0.46	1	50	19,600
BREF-205005015	KY21650	0.5	0.05	0.5	0.46	1.5	50	19,600
BREF-205005020	KY22632	0.5	0.05	0.5	0.46	2	50	20,300
BREF-205005030	KY21651	0.5	0.05	0.5	0.46	3	50	20,300
BREF-205010005	KY22633	0.5	0.1	0.5	—	0.5	50	19,100
BREF-205010010	KY22634	0.5	0.1	0.5	0.46	1	50	19,600
BREF-205010015	KY21652	0.5	0.1	0.5	0.46	1.5	50	19,600
BREF-205010020	KY22635	0.5	0.1	0.5	0.46	2	50	20,300
BREF-205010030	KY21653	0.5	0.1	0.5	0.46	3	50	20,300
BREF-210003020	KY22636	1	0.03	1	0.95	2	50	18,700
BREF-210003030	KY21654	1	0.03	1	0.95	3	50	18,700
BREF-210003040	KY22637	1	0.03	1	0.95	4	50	19,600
BREF-210003050	KY22638	1	0.03	1	0.95	5	50	19,600
BREF-210003060	KY21655	1	0.03	1	0.95	6	50	19,600
BREF-210003080	KY22639	1	0.03	1	0.95	8	50	21,500
BREF-210003100	KY22640	1	0.03	1	0.95	10	50	22,400
BREF-210005020	KY22641	1	0.05	1	0.95	2	50	18,700
BREF-210005030	KY21656	1	0.05	1	0.95	3	50	18,700
BREF-210005040	KY22642	1	0.05	1	0.95	4	50	19,600
BREF-210005050	KY22643	1	0.05	1	0.95	5	50	19,600
BREF-210005060	KY21657	1	0.05	1	0.95	6	50	19,600
BREF-210005080	KY22644	1	0.05	1	0.95	8	50	21,500
BREF-210005100	KY22645	1	0.05	1	0.95	10	50	22,400

型番	ツールNo.	刃径 D	コーナー R	刃長 ℓ	首下径 d1	有効長 ℓ1	全長 L	価格
BREF-210010020	KY22646	1	0.1	1	0.95	2	50	18,700
BREF-210010030	KY21658	1	0.1	1	0.95	3	50	18,700
BREF-210010040	KY22647	1	0.1	1	0.95	4	50	19,600
BREF-210010050	KY22648	1	0.1	1	0.95	5	50	19,600
BREF-210010060	KY21659	1	0.1	1	0.95	6	50	19,600
BREF-210010080	KY22649	1	0.1	1	0.95	8	50	21,500
BREF-210010100	KY22650	1	0.1	1	0.95	10	50	22,400
BREF-210020020	KY22651	1	0.2	1	0.95	2	50	18,700
BREF-210020030	KY21660	1	0.2	1	0.95	3	50	18,700
BREF-210020040	KY22652	1	0.2	1	0.95	4	50	19,600
BREF-210020050	KY22653	1	0.2	1	0.95	5	50	19,600
BREF-210020060	KY21661	1	0.2	1	0.95	6	50	19,600
BREF-210020080	KY22654	1	0.2	1	0.95	8	50	21,500
BREF-210020100	KY22655	1	0.2	1	0.95	10	50	22,400
BREF-215003045	KY21662	1.5	0.03	1.5	1.45	4.5	50	20,300
BREF-215003090	KY21663	1.5	0.03	1.5	1.45	9	50	21,200
BREF-215005045	KY21664	1.5	0.05	1.5	1.45	4.5	50	20,300
BREF-215005090	KY21665	1.5	0.05	1.5	1.45	9	50	21,200
BREF-215010045	KY21666	1.5	0.1	1.5	1.45	4.5	50	20,300
BREF-215010090	KY21667	1.5	0.1	1.5	1.45	9	50	21,200
BREF-215020045	KY21668	1.5	0.2	1.5	1.45	4.5	50	20,300
BREF-215020090	KY21669	1.5	0.2	1.5	1.45	9	50	21,200
BREF-220003060	KY21670	2	0.03	1.5	1.95	6	50	21,200
BREF-220003120	KY21671	2	0.03	1.5	1.95	12	50	22,700
BREF-220005060	KY21672	2	0.05	1.5	1.95	6	50	21,200
BREF-220005120	KY21673	2	0.05	1.5	1.95	12	50	22,700
BREF-220010060	KY21674	2	0.1	1.5	1.95	6	50	21,200
BREF-220010120	KY21675	2	0.1	1.5	1.95	12	50	22,700
BREF-220020060	KY21676	2	0.2	1.5	1.95	6	50	21,200
BREF-220020120	KY21677	2	0.2	1.5	1.95	12	50	22,700
BREF-220030060	KY21678	2	0.3	1.5	1.95	6	50	21,200
BREF-220030120	KY21679	2	0.3	1.5	1.95	12	50	22,700
BREF-230003090	KY21680	3	0.03	2	2.95	9	50	28,600
BREF-230003180	KY21681	3	0.03	2	2.95	18	60	29,900
BREF-230005090	KY21682	3	0.05	2	2.95	9	50	28,600
BREF-230005180	KY21683	3	0.05	2	2.95	18	60	29,900
BREF-230010090	KY21684	3	0.1	2	2.95	9	50	28,600
BREF-230010180	KY21685	3	0.1	2	2.95	18	60	29,900
BREF-230020090	KY21686	3	0.2	2	2.95	9	50	28,600
BREF-230020180	KY21687	3	0.2	2	2.95	18	60	29,900
BREF-230030090	KY21688	3	0.3	2	2.95	9	50	28,600
BREF-230030180	KY21689	3	0.3	2	2.95	18	60	29,900
BREF-230050090	KY21690	3	0.5	2	2.95	9	50	28,600
BREF-230050180	KY21691	3	0.5	2	2.95	18	60	29,900

# CBNテーパネック コーナーR付エンドミル



## YBRETN形

2枚刃  
直刃  
電界砥粒制御研磨

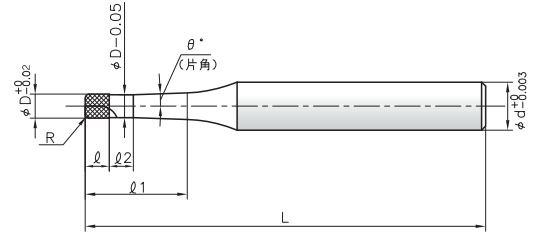

●切削条件 P.68

型番	ツールNo.	刃径 D	コーナー R	刃長 ℓ	有効長 ℓ1	首勾配角 θ°	全長 L	柄径 d	価格
YBRETN-2050201-05	KY21524	0.5	0.1	0.5	2	30'	40	4	42,670
YBRETN-2050201-10	KY21525	0.5	0.1	0.5	2	1°	40	4	42,670
YBRETN-2050201-20	KY21526	0.5	0.1	0.5	2	2°	40	4	42,670
YBRETN-2050401-05	KY21527	0.5	0.1	0.5	4	30'	40	4	49,340
YBRETN-2050401-10	KY21528	0.5	0.1	0.5	4	1°	40	4	49,340
YBRETN-2050401-20	KY21529	0.5	0.1	0.5	4	2°	40	4	49,340
YBRETN-2060201-05	KY21530	0.6	0.1	0.5	2	30'	40	4	44,000
YBRETN-2060201-10	KY21531	0.6	0.1	0.5	2	1°	40	4	44,000
YBRETN-2060201-20	KY21532	0.6	0.1	0.5	2	2°	40	4	44,000
YBRETN-2060401-05	KY21533	0.6	0.1	0.5	4	30'	40	4	50,000
YBRETN-2060401-10	KY21534	0.6	0.1	0.5	4	1°	40	4	50,000
YBRETN-2060401-20	KY21535	0.6	0.1	0.5	4	2°	40	4	50,000
YBRETN-2070201-05	KY21536	0.7	0.1	0.5	2	30'	40	4	44,000
YBRETN-2070201-10	KY21537	0.7	0.1	0.5	2	1°	40	4	44,000
YBRETN-2070201-20	KY21538	0.7	0.1	0.5	2	2°	40	4	44,000
YBRETN-2070401-05	KY21539	0.7	0.1	0.5	4	30'	40	4	50,000
YBRETN-2070401-10	KY21540	0.7	0.1	0.5	4	1°	40	4	50,000
YBRETN-2070401-20	KY21541	0.7	0.1	0.5	4	2°	40	4	50,000
YBRETN-2080401-05	KY21542	0.8	0.1	0.8	4	30'	40	4	47,340
YBRETN-2080401-10	KY21543	0.8	0.1	0.8	4	1°	40	4	47,340
YBRETN-2080401-20	KY21544	0.8	0.1	0.8	4	2°	40	4	47,340
YBRETN-2080601-05	KY21545	0.8	0.1	0.8	6	30'	40	4	54,000
YBRETN-2080601-10	KY21546	0.8	0.1	0.8	6	1°	40	4	54,000
YBRETN-2080601-20	KY21547	0.8	0.1	0.8	6	2°	40	4	54,000
YBRETN-2090401-05	KY21548	0.9	0.1	0.8	4	30'	40	4	47,340
YBRETN-2090401-10	KY21549	0.9	0.1	0.8	4	1°	40	4	47,340
YBRETN-2090401-20	KY21550	0.9	0.1	0.8	4	2°	40	4	47,340
YBRETN-2090601-05	KY21551	0.9	0.1	0.8	6	30'	40	4	54,000
YBRETN-2090601-10	KY21552	0.9	0.1	0.8	6	1°	40	4	54,000
YBRETN-2090601-20	KY21553	0.9	0.1	0.8	6	2°	40	4	54,000
YBRETN-2100601-05	KY21554	1	0.1	1	6	30'	50	4	40,670
YBRETN-2100601-10	KY21555	1	0.1	1	6	1°	50	4	40,670
YBRETN-2100601-20	KY21556	1	0.1	1	6	2°	50	4	40,670
YBRETN-2100801-05	KY21557	1	0.1	1	8	30'	50	4	47,340
YBRETN-2100801-10	KY21558	1	0.1	1	8	1°	50	4	47,340
YBRETN-2100801-20	KY21559	1	0.1	1	8	2°	50	4	47,340
YBRETN-2101001-05	KY21560	1	0.1	1	10	30'	50	4	58,340
YBRETN-2101001-10	KY21561	1	0.1	1	10	1°	50	4	58,340
YBRETN-2101001-20	KY21562	1	0.1	1	10	2°	50	4	58,340
YBRETN-2100602-05	KY21563	1	0.2	1	6	30'	50	4	40,670
YBRETN-2100602-10	KY21564	1	0.2	1	6	1°	50	4	40,670
YBRETN-2100602-20	KY21565	1	0.2	1	6	2°	50	4	40,670
YBRETN-2100802-05	KY21566	1	0.2	1	8	30'	50	4	47,340
YBRETN-2100802-10	KY21567	1	0.2	1	8	1°	50	4	47,340
YBRETN-2100802-20	KY21568	1	0.2	1	8	2°	50	4	47,340
YBRETN-2101002-05	KY21569	1	0.2	1	10	30'	50	4	58,340
YBRETN-2101002-10	KY21570	1	0.2	1	10	1°	50	4	58,340
YBRETN-2101002-20	KY21571	1	0.2	1	10	2°	50	4	58,340
YBRETN-2150601-05	KY21572	1.5	0.1	1	6	30'	50	4	48,670
YBRETN-2150601-10	KY21573	1.5	0.1	1	6	1°	50	4	48,670

型番	ツールNo.	刃径 D	コーナー R	刃長 ℓ	有効長 ℓ1	首勾配角 θ°	全長 L	柄径 d	価格
YBRETN-2150601-20	KY21574	1.5	0.1	1	6	2°	50	4	48,670
YBRETN-2150801-05	KY21575	1.5	0.1	1	8	30'	50	4	56,670
YBRETN-2150801-10	KY21576	1.5	0.1	1	8	1°	50	4	56,670
YBRETN-2150801-20	KY21577	1.5	0.1	1	8	2°	50	4	56,670
YBRETN-2151001-05	KY21578	1.5	0.1	1	10	30'	50	4	66,670
YBRETN-2151001-10	KY21579	1.5	0.1	1	10	1°	50	4	66,670
YBRETN-2151001-20	KY21580	1.5	0.1	1	10	2°	50	4	66,670
YBRETN-2150602-05	KY21581	1.5	0.2	1	6	30'	50	4	48,670
YBRETN-2150602-10	KY21582	1.5	0.2	1	6	1°	50	4	48,670
YBRETN-2150602-20	KY21583	1.5	0.2	1	6	2°	50	4	48,670
YBRETN-2150802-05	KY21584	1.5	0.2	1	8	30'	50	4	56,670
YBRETN-2150802-10	KY21585	1.5	0.2	1	8	1°	50	4	56,670
YBRETN-2150802-20	KY21586	1.5	0.2	1	8	2°	50	4	56,670
YBRETN-2151002-05	KY21587	1.5	0.2	1	10	30'	50	4	66,670
YBRETN-2151002-10	KY21588	1.5	0.2	1	10	1°	50	4	66,670
YBRETN-2151002-20	KY21589	1.5	0.2	1	10	2°	50	4	66,670
YBRETN-2200801-05	KY21590	2	0.1	2	8	30'	50	4	50,000
YBRETN-2200801-10	KY21591	2	0.1	2	8	1°	50	4	50,000
YBRETN-2200801-20	KY21592	2	0.1	2	8	2°	50	4	50,000
YBRETN-2201001-05	KY21593	2	0.1	2	10	30'	50	4	58,340
YBRETN-2201001-10	KY21594	2	0.1	2	10	1°	50	4	58,340
YBRETN-2201001-20	KY21595	2	0.1	2	10	2°	50	4	58,340
YBRETN-2201201-05	KY21596	2	0.1	2	12	30'	50	4	73,340
YBRETN-2201201-10	KY21597	2	0.1	2	12	1°	50	4	73,340
YBRETN-2201201-20	KY21598	2	0.1	2	12	2°	50	4	73,340
YBRETN-2200802-05	KY21599	2	0.2	2	8	30'	50	4	50,000
YBRETN-2200802-10	KY21600	2	0.2	2	8	1°	50	4	50,000
YBRETN-2200802-20	KY21601	2	0.2	2	8	2°	50	4	50,000
YBRETN-2201002-05	KY21602	2	0.2	2	10	30'	50	4	58,340
YBRETN-2201002-10	KY21603	2	0.2	2	10	1°	50	4	58,340
YBRETN-2201002-20	KY21604	2	0.2	2	10	2°	50	4	58,340
YBRETN-2201202-05	KY21605	2	0.2	2	12	30'	50	4	73,340
YBRETN-2201202-10	KY21606	2	0.2	2	12	1°	50	4	73,340
YBRETN-2201202-20	KY21607	2	0.2	2	12	2°	50	4	73,340
YBRETN-2200803-05	KY21608	2	0.3	2	8	30'	50	4	50,000
YBRETN-2200803-10	KY21609	2	0.3	2	8	1°	50	4	50,000
YBRETN-2200803-20	KY21610	2	0.3	2	8	2°	50	4	50,000
YBRETN-2201003-05	KY21611	2	0.3	2	10	30'	50	4	58,340
YBRETN-2201003-10	KY21612	2	0.3	2	10	1°	50	4	58,340
YBRETN-2201003-20	KY21613	2	0.3	2	10	2°	50	4	58,340
YBRETN-2201203-05	KY21614	2	0.3	2	12	30'	50	4	73,340
YBRETN-2201203-10	KY21615	2	0.3	2	12	1°	50	4	73,340
YBRETN-2201203-20	KY21616	2	0.3	2	12	2°	50	4	73,340
YBRETN-2301201-05	KY21617	3	0.1	2	12	30'	60	6	58,340
YBRETN-2301201-10	KY21618	3	0.1	2	12	1°	60	6	58,340
YBRETN-2301201-20	KY21619	3	0.1	2	12	2°	60	6	58,340
YBRETN-2301401-05	KY21620	3	0.1	2	14	30'	60	6	66,670
YBRETN-2301401-10	KY21621	3	0.1	2	14	1°	60	6	66,670
YBRETN-2301401-20	KY21622	3	0.1	2	14	2°	60	6	66,670
YBRETN-2301601-05	KY21623	3	0.1	2	16	30'	60	6	86,000

# アタックスミス CBNコーナーR付エンドミル

## BRE形

φ6シャンク  
2枚刃  
直刃  
電界砥粒制御研磨

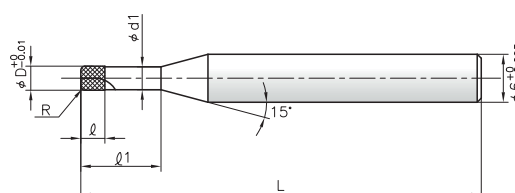

型番	ツールNo.	刃径 D	コー ナー R	刃長 ℓ	有効長 ℓ1	首勾配角 θ°	全長 L	柄径 d	価格
YBRETN-2301601-10	KY21624	3	0.1	2	16	1°	60	6	86,000
YBRETN-2301601-20	KY21625	3	0.1	2	16	2°	60	6	86,000
YBRETN-2301202-05	KY21626	3	0.2	2	12	30'	60	6	58,340
YBRETN-2301202-10	KY21627	3	0.2	2	12	1°	60	6	58,340
YBRETN-2301202-20	KY21628	3	0.2	2	12	2°	60	6	58,340
YBRETN-2301402-05	KY21629	3	0.2	2	14	30'	60	6	66,670
YBRETN-2301402-10	KY21630	3	0.2	2	14	1°	60	6	66,670
YBRETN-2301402-20	KY21631	3	0.2	2	14	2°	60	6	66,670
YBRETN-2301602-05	KY21632	3	0.2	2	16	30'	60	6	86,000
YBRETN-2301602-10	KY21633	3	0.2	2	16	1°	60	6	86,000
YBRETN-2301602-20	KY21634	3	0.2	2	16	2°	60	6	86,000
YBRETN-2301203-05	KY21635	3	0.3	2	12	30'	60	6	58,340
YBRETN-2301203-10	KY21636	3	0.3	2	12	1°	60	6	58,340
YBRETN-2301203-20	KY21637	3	0.3	2	12	2°	60	6	58,340
YBRETN-2301403-05	KY21638	3	0.3	2	14	30'	60	6	66,670
YBRETN-2301402-10	KY21639	3	0.3	2	14	1°	60	6	66,670
YBRETN-2301402-20	KY21640	3	0.3	2	14	2°	60	6	66,670
YBRETN-2301603-05	KY21641	3	0.3	2	16	30'	60	6	86,000
YBRETN-2301603-10	KY21642	3	0.3	2	16	1°	60	6	86,000
YBRETN-2301603-20	KY21643	3	0.3	2	16	2°	60	6	86,000

●切削条件 P.68

型番	ツールNo.	刃径 D	コー ナー R	刃長 ℓ	首下径 d1	有効長 ℓ1	全長 L	価格
BRE-203005S	KY22314	0.3	0.05	0.3	0.26	0.9	50	22,000
BRE-204005S	KY22315	0.4	0.05	0.4	0.36	1.2	50	20,800
BRE-205010S	KY21439	0.5	0.1	0.5	0.46	1.5	50	20,300
BRE-210010S	KY21440	1	0.1	1	0.95	3	50	19,600
BRE-210020S	KY21441	1	0.2	1	0.95	3	50	19,600
BRE-215010S	KY21442	1.5	0.1	1.5	1.45	4.5	50	21,400
BRE-215020S	KY21443	1.5	0.2	1.5	1.45	4.5	50	21,400
BRE-220020S	KY21444	2	0.2	1.5	1.95	6	50	22,500
BRE-220030S	KY21445	2	0.3	1.5	1.95	6	50	22,500
BRE-230020S	KY21446	3	0.2	2	2.95	9	50	29,800
BRE-230030S	KY21447	3	0.3	2	2.95	9	50	29,800
BRE-230050S	KY21448	3	0.5	2	2.95	9	50	29,800
BRE-240003S	KY22316	4	0.03	2	3.95	12	50	37,000
BRE-240020S	KY22317	4	0.2	2	3.95	12	50	37,000
BRE-240030S	KY22318	4	0.3	2	3.95	12	50	37,000
BRE-240050S	KY22319	4	0.5	2	3.95	12	50	37,000
BRE-250003S	KY22320	5	0.03	2	4.95	15	60	38,900
BRE-250020S	KY22321	5	0.2	2	4.95	15	60	38,900
BRE-250030S	KY22322	5	0.3	2	4.95	15	60	38,900
BRE-250050S	KY22323	5	0.5	2	4.95	15	60	38,900
BRE-260003S	KY22324	6	0.03	2	5.95	20	60	44,100
BRE-260020S	KY22325	6	0.2	2	5.95	20	60	44,100
BRE-260030S	KY22326	6	0.3	2	5.95	20	60	44,100
BRE-260050S	KY22327	6	0.5	2	5.95	20	60	44,100



## アタックミス CBNコーナーR付エンドミル

### BREF-1形

φ4シャンク  
1枚刃  
直刃  
電界砥粒制御研磨

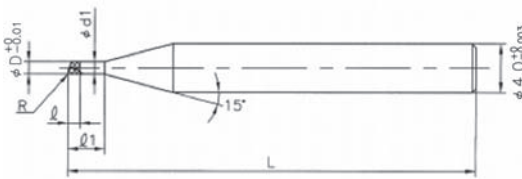

## アタックミス CBNスパイラルコーナーR付エンドミル

### SBREF-2形

φ4シャンク  
2枚刃  
スパイラル刃  
電界砥粒制御研磨

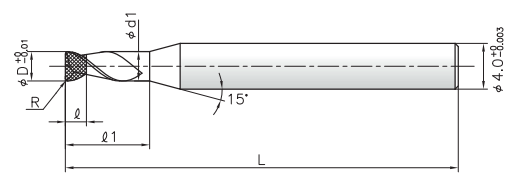

●切削条件 P.69

型番	ツールNo.	刃径 D	コーナー R	刃長 ℓ	首下径 d1	有効長 ℓ1	全長 L	価格
BREF-101001003	KY22593	0.1	0.01	0.1	0.09	0.3	50	40,500
BREF-101001005	KY22594	0.1	0.01	0.1	0.09	0.5	50	41,000
BREF-102001006	KY22595	0.2	0.01	0.2	0.18	0.6	50	38,000
BREF-102001012	KY22596	0.2	0.01	0.2	0.18	1.2	50	38,500
BREF-102002006	KY22597	0.2	0.02	0.2	0.18	0.6	50	37,000
BREF-102002012	KY22598	0.2	0.02	0.2	0.18	1.2	50	37,500
BREF-103001009	KY22599	0.3	0.01	0.3	0.28	0.9	50	36,000
BREF-103001018	KY22600	0.3	0.01	0.3	0.28	1.8	50	36,500
BREF-103002009	KY22601	0.3	0.02	0.3	0.28	0.9	50	34,000
BREF-103002018	KY22602	0.3	0.02	0.3	0.28	1.8	50	34,500
BREF-104001012	KY22603	0.4	0.01	0.4	0.37	1.2	50	29,000
BREF-104001024	KY22604	0.4	0.01	0.4	0.37	2.4	50	29,500
BREF-104002012	KY22605	0.4	0.02	0.4	0.37	1.2	50	27,000
BREF-104002024	KY22606	0.4	0.02	0.4	0.37	2.4	50	27,500
BREF-105001015	KY22607	0.5	0.01	0.5	0.46	1.5	50	26,000
BREF-105001030	KY22608	0.5	0.01	0.5	0.46	3	50	26,500
BREF-105002015	KY22609	0.5	0.02	0.5	0.46	1.5	50	25,000
BREF-105002030	KY22610	0.5	0.02	0.5	0.46	3	50	25,500
BREF-110001030	KY22611	1	0.01	1	0.95	3	50	24,000
BREF-110001060	KY22612	1	0.01	1	0.95	6	50	25,000
BREF-110002030	KY22613	1	0.02	1	0.95	3	50	24,000
BREF-110002060	KY22614	1	0.02	1	0.95	6	50	25,000

●切削条件 P.67

型番	ツールNo.	刃径 D	コーナー R	刃長 ℓ	首下径 d1	有効長 ℓ1	全長 L	価格
SBREF-203003009	KY22429	0.3	0.03	0.3	0.26	0.9	50	25,500
SBREF-203003018	KY22430	0.3	0.03	0.3	0.26	1.8	50	26,200
SBREF-203005009	KY22431	0.3	0.05	0.3	0.26	0.9	50	25,500
SBREF-203005018	KY22432	0.3	0.05	0.3	0.26	1.8	50	26,200
SBREF-204003012	KY22433	0.4	0.03	0.4	0.36	1.2	50	24,100
SBREF-204003024	KY22434	0.4	0.03	0.4	0.36	2.4	50	24,800
SBREF-204010012	KY22435	0.4	0.1	0.4	0.36	1.2	50	24,100
SBREF-204010024	KY22436	0.4	0.1	0.4	0.36	2.4	50	24,800
SBREF-205003015	KY22437	0.5	0.03	0.5	0.46	1.5	50	23,600
SBREF-205003030	KY22438	0.5	0.03	0.5	0.46	3	50	24,300
SBREF-205010015	KY22439	0.5	0.1	0.5	0.46	1.5	50	23,600
SBREF-205010030	KY22440	0.5	0.1	0.5	0.46	3	50	24,300
SBREF-210003030	KY22441	1	0.03	1	0.95	3	50	22,400
SBREF-210003040	KY22442	1	0.03	1	0.95	4	50	23,400
SBREF-210003050	KY22443	1	0.03	1	0.95	5	50	23,400
SBREF-210003060	KY22444	1	0.03	1	0.95	6	50	23,400
SBREF-210003080	KY22445	1	0.03	1	0.95	8	50	25,800
SBREF-210003100	KY22446	1	0.03	1	0.95	10	50	27,000
SBREF-210010030	KY22447	1	0.1	1	0.95	3	50	22,400
SBREF-210010040	KY22448	1	0.1	1	0.95	4	50	23,400
SBREF-210010050	KY22449	1	0.1	1	0.95	5	50	23,400
SBREF-210010060	KY22450	1	0.1	1	0.95	6	50	23,400
SBREF-210010080	KY22451	1	0.1	1	0.95	8	50	25,800
SBREF-210010100	KY22452	1	0.1	1	0.95	10	50	27,000
SBREF-210020030	KY22453	1	0.2	1	0.95	3	50	22,400
SBREF-210020040	KY22454	1	0.2	1	0.95	4	50	23,400
SBREF-210020050	KY22455	1	0.2	1	0.95	5	50	23,400
SBREF-210020060	KY22456	1	0.2	1	0.95	6	50	23,400
SBREF-210020080	KY22457	1	0.2	1	0.95	8	50	25,800
SBREF-210020100	KY22458	1	0.2	1	0.95	10	50	27,000
SBREF-215003045	KY22459	1.5	0.03	1.5	1.45	4.5	50	24,300
SBREF-215003090	KY22460	1.5	0.03	1.5	1.45	9	50	25,500
SBREF-215010045	KY22461	1.5	0.1	1.5	1.45	4.5	50	24,300
SBREF-215010090	KY22462	1.5	0.1	1.5	1.45	9	50	25,500
SBREF-215020045	KY22463	1.5	0.2	1.5	1.45	4.5	50	24,300
SBREF-215020090	KY22464	1.5	0.2	1.5	1.45	9	50	25,500
SBREF-220003060	KY22465	2	0.03	1.5	1.95	6	50	25,500
SBREF-220003120	KY22466	2	0.03	1.5	1.95	12	50	27,000

# アタックスミス CBNスパイラルコーナーR付エンドミル

## SBRE-2形

φ6シャンク  
2枚刃  
スパイラル刃  
電界砥粒制御研磨

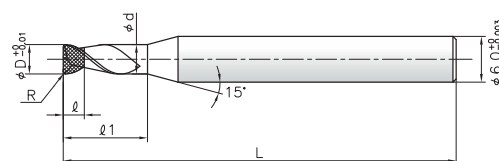

●切削条件 P.67

型番	ツールNo.	刃径 D	コーナー R	刃長 l	首下径 d1	有効長 l1	全長 L	価格
SBREF-220010060	KY22467	2	0.1	1.5	1.95	6	50	25,500
SBREF-220010120	KY22468	2	0.1	1.5	1.95	12	50	27,000
SBREF-220020060	KY22469	2	0.2	1.5	1.95	6	50	25,500
SBREF-220020120	KY22470	2	0.2	1.5	1.95	12	50	27,000
SBREF-220030060	KY22471	2	0.3	1.5	1.95	6	50	25,500
SBREF-220030120	KY22472	2	0.3	1.5	1.95	12	50	27,000
SBREF-230003090	KY22473	3	0.03	2	2.95	9	50	34,500
SBREF-230003180	KY22474	3	0.03	2	2.95	18	60	35,800
SBREF-230010090	KY22475	3	0.1	2	2.95	9	50	34,500
SBREF-230010180	KY22476	3	0.1	2	2.95	18	60	35,800
SBREF-230020090	KY22477	3	0.2	2	2.95	9	50	34,500
SBREF-230020180	KY22478	3	0.2	2	2.95	18	60	35,800
SBREF-230030090	KY22479	3	0.3	2	2.95	9	50	34,500
SBREF-230030180	KY22480	3	0.3	2	2.95	18	60	35,800
SBREF-230050090	KY22481	3	0.5	2	2.95	9	50	34,500
SBREF-230050180	KY22482	3	0.5	2	2.95	18	60	35,800

型番	ツールNo.	刃径 D	コーナー R	刃長 l	首下径 d1	有効長 l1	全長 L	価格
SBRE-203005	KY22370	0.3	0.05	0.3	0.26	0.9	50	26,200
SBRE-204005	KY22371	0.4	0.05	0.4	0.36	1.2	50	24,800
SBRE-205010	KY22372	0.5	0.1	0.5	0.46	1.5	50	24,300
SBRE-210010	KY22373	1	0.1	1	0.95	3	50	23,400
SBRE-210020	KY22374	1	0.2	1	0.95	3	50	23,400
SBRE-215010	KY22375	1.5	0.1	1.5	1.45	4.5	50	25,500
SBRE-215020	KY22376	1.5	0.2	1.5	1.45	4.5	50	25,500
SBRE-220020	KY22377	2	0.2	1.5	1.95	6	50	27,000
SBRE-220030	KY22378	2	0.3	1.5	1.95	6	50	27,000
SBRE-230020	KY22379	3	0.2	2	2.95	9	50	35,800
SBRE-230030	KY22380	3	0.3	2	2.95	9	50	35,800
SBRE-230050	KY22381	3	0.5	2	2.95	9	50	35,800
SBRE-240003	KY22382	4	0.03	2	3.95	12	50	44,300
SBRE-240010	KY22383	4	0.1	2	3.95	12	50	44,300
SBRE-240020	KY22384	4	0.2	2	3.95	12	50	44,300
SBRE-240030	KY22385	4	0.3	2	3.95	12	50	44,300
SBRE-240050	KY22386	4	0.5	2	3.95	12	50	44,300
SBRE-250003	KY22387	5	0.03	2	4.95	15	60	46,500
SBRE-250010	KY22388	5	0.1	2	4.95	15	60	46,500
SBRE-250020	KY22389	5	0.2	2	4.95	15	60	46,500
SBRE-250030	KY22390	5	0.3	2	4.95	15	60	46,500
SBRE-250050	KY22391	5	0.5	2	4.95	15	60	46,500
SBRE-260003	KY22392	6	0.03	2	5.95	20	60	53,100
SBRE-260010	KY22393	6	0.1	2	5.95	20	60	53,100
SBRE-260020	KY22394	6	0.2	2	5.95	20	60	53,100
SBRE-260030	KY22395	6	0.3	2	5.95	20	60	53,100
SBRE-260050	KY22396	6	0.5	2	5.95	20	60	53,100

# アタックスミス CBNスパイラルコーナーR付エンドミル

## SBREF-3形

φ4シャンク  
3枚刃  
スパイラル刃  
電界砥粒制御研磨

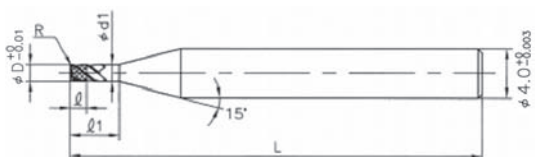

●切削条件 P.69

型番	ツールNo.	刃径 D	コーナー R	刃長 ℓ	首下径 d1	有効長 ℓ1	全長 L	価格
SBREF-303002010	KY22679	0.3	0.02	0.5	0.26	1	50	30,000
SBREF-303002020	KY22680	0.3	0.02	0.5	0.26	2	50	30,700
SBREF-303005010	KY22681	0.3	0.05	0.5	0.26	1	50	30,000
SBREF-303005020	KY22682	0.3	0.05	0.5	0.26	2	50	30,700
SBREF-304002012	KY22683	0.4	0.02	0.5	0.36	1.2	50	28,400
SBREF-304002024	KY22684	0.4	0.02	0.5	0.36	2.4	50	29,100
SBREF-304005012	KY22685	0.4	0.05	0.5	0.36	1.2	50	28,400
SBREF-304005024	KY22686	0.4	0.05	0.5	0.36	2.4	50	29,100
SBREF-305002015	KY22491	0.5	0.02	0.5	0.46	1.5	50	27,600
SBREF-305002030	KY22492	0.5	0.02	0.5	0.46	3	50	28,600
SBREF-305010015	KY22493	0.5	0.1	0.5	0.46	1.5	50	27,600
SBREF-305010030	KY22494	0.5	0.1	0.5	0.46	3	50	28,600
SBREF-306002018	KY22495	0.6	0.02	0.6	0.56	1.8	50	27,600
SBREF-306002036	KY22496	0.6	0.02	0.6	0.56	3.6	50	28,600
SBREF-306010018	KY22497	0.6	0.1	0.6	0.56	1.8	50	27,600
SBREF-306010036	KY22498	0.6	0.1	0.6	0.56	3.6	50	28,600
SBREF-307002021	KY22499	0.7	0.02	0.7	0.66	2.1	50	27,600
SBREF-307002042	KY22500	0.7	0.02	0.7	0.66	4.2	50	28,600
SBREF-307010021	KY22501	0.7	0.1	0.7	0.66	2.1	50	27,600
SBREF-307010042	KY22502	0.7	0.1	0.7	0.66	4.2	50	28,600
SBREF-308002024	KY22503	0.8	0.02	0.8	0.76	2.4	50	27,000
SBREF-308002048	KY22504	0.8	0.02	0.8	0.76	4.8	50	28,000
SBREF-308010024	KY22505	0.8	0.1	0.8	0.76	2.4	50	27,000
SBREF-308010048	KY22506	0.8	0.1	0.8	0.76	4.8	50	28,000
SBREF-309002027	KY22507	0.9	0.02	0.9	0.85	2.7	50	27,000
SBREF-309002054	KY22508	0.9	0.02	0.9	0.85	5.4	50	28,000
SBREF-309010027	KY22509	0.9	0.1	0.9	0.85	2.7	50	27,000
SBREF-309010054	KY22510	0.9	0.1	0.9	0.85	5.4	50	28,000
SBREF-310002030	KY22511	1	0.02	1	0.95	3	50	26,400
SBREF-310002040	KY22512	1	0.02	1	0.95	4	50	27,400
SBREF-310002050	KY22513	1	0.02	1	0.95	5	50	27,400
SBREF-310002060	KY22514	1	0.02	1	0.95	6	50	27,400
SBREF-310002080	KY22515	1	0.02	1	0.95	8	50	30,200
SBREF-310002100	KY22516	1	0.02	1	0.95	10	50	31,600
SBREF-310010030	KY22517	1	0.1	1	0.95	3	50	26,400
SBREF-310010040	KY22518	1	0.1	1	0.95	4	50	27,400
SBREF-310010050	KY22519	1	0.1	1	0.95	5	50	27,400
SBREF-310010060	KY22520	1	0.1	1	0.95	6	50	27,400

型番	ツールNo.	刃径 D	コーナー R	刃長 ℓ	首下径 d1	有効長 ℓ1	全長 L	価格
SBREF-310010080	KY22521	1	0.1	1	0.95	8	50	30,200
SBREF-310010100	KY22522	1	0.1	1	0.95	10	50	31,600
SBREF-315002045	KY22523	1.5	0.02	1.5	1.45	4.5	50	28,600
SBREF-315002090	KY22524	1.5	0.02	1.5	1.45	9	50	30,000
SBREF-315010045	KY22525	1.5	0.1	1.5	1.45	4.5	50	28,600
SBREF-315010090	KY22526	1.5	0.1	1.5	1.45	9	50	30,000
SBREF-320002060	KY22527	2	0.02	1.5	1.95	6	50	30,000
SBREF-320002120	KY22528	2	0.02	1.5	1.95	12	50	31,800
SBREF-320010060	KY22529	2	0.1	1.5	1.95	6	50	30,000
SBREF-320010120	KY22530	2	0.1	1.5	1.95	12	50	31,800
SBREF-320020060	KY22531	2	0.2	1.5	1.95	6	50	30,000
SBREF-320020120	KY22532	2	0.2	1.5	1.95	12	50	31,800

## アタックスミス CBNスパイラルコーナーR付エンドミル

### SBRE-3形

φ6シャンク  
3枚刃  
スパイラル刃  
電界砥粒制御研磨

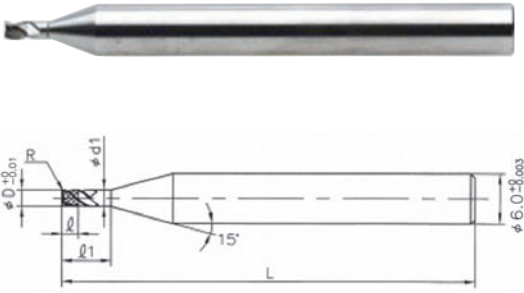

●切削条件 P.69

型番	ツールNo.	刃径 D	コーナー R	刃長 ℓ	首下径 d1	有効長 ℓ1	全長 L	価格
SBRE-330002090	KY22687	3	0.02	1.5	2.95	9	50	40,500
SBRE-330002180	KY22688	3	0.02	1.5	2.95	18	50	42,000
SBRE-330010090	KY22689	3	0.1	1.5	2.95	9	50	40,500
SBRE-330010180	KY22690	3	0.1	1.5	2.95	18	50	42,000
SBRE-330020090	KY22691	3	0.2	1.5	2.95	9	50	40,500
SBRE-330020180	KY22692	3	0.2	1.5	2.95	18	50	42,000
SBRE-330050090	KY22693	3	0.5	1.5	2.95	9	50	40,500
SBRE-330050180	KY22694	3	0.5	1.5	2.95	18	50	42,000
SBRE-340005200	KY22695	4	0.05	2	3.95	20	60	52,100
SBRE-340010200	KY22696	4	0.1	2	3.95	20	60	52,100
SBRE-340020200	KY22697	4	0.2	2	3.95	20	60	52,100
SBRE-340050200	KY22698	4	0.5	2	3.95	20	60	52,100
SBRE-350005240	KY22699	5	0.05	2	4.95	24	70	54,700
SBRE-350010240	KY22700	5	0.1	2	4.95	24	70	54,700
SBRE-350020240	KY22701	5	0.2	2	4.95	24	70	54,700
SBRE-350050240	KY22702	5	0.5	2	4.95	24	70	54,700
SBRE-360005300	KY22703	6	0.05	2	5.95	30	70	62,400
SBRE-360010300	KY22704	6	0.1	2	5.95	30	70	62,400
SBRE-360020300	KY22705	6	0.2	2	5.95	30	70	62,400
SBRE-360050300	KY22706	6	0.5	2	5.95	30	70	62,400

## アタックスミス CBN V形エンドミル

### BVEF形

φ4シャンク  
2枚刃  
直刃

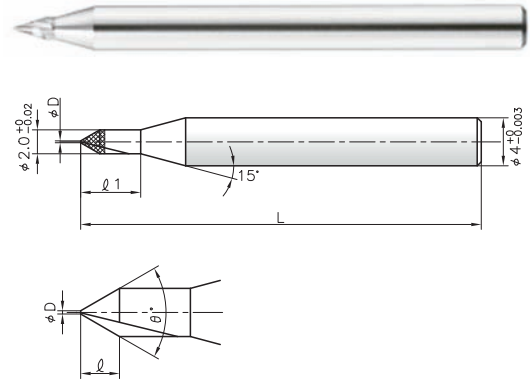

●切削条件 P.70

型番	ツールNo.	先端角 θ°	先端径 D	刃長 ℓ	有効長 ℓ1	全長 L	価格
BVEF-2030005	KY21712	30°	0.05	3.64	6	50	28,600
BVEF-2030010	KY21713	30°	0.1	3.54	6	50	28,600
BVEF-2040005	KY21714	40°	0.05	2.68	4	50	28,600
BVEF-2040010	KY21715	40°	0.1	2.61	4	50	28,600
BVEF-2060005	KY21716	60°	0.05	1.69	4	50	26,000
BVEF-2060010	KY21717	60°	0.1	1.65	4	50	26,000
BVEF-2090005	KY21718	90°	0.05	0.975	4	50	26,000
BVEF-2090010	KY21719	90°	0.1	0.95	4	50	26,000

## アタックスミス CBN V形R付エンドミル

### BVREF形

φ4シャンク  
2枚刃  
直刃

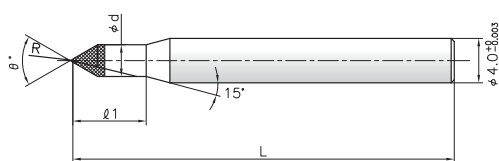

●切削条件 P.70

型番	ツールNo.	先端角 θ°	先端 R	刃長 ℓ	有効長 ℓ1	首径 d	全長 L	価格
BVREF-2030010	KY22483	30°	0.1	3.64	6	2	50	34,100
BVREF-2030020	KY22484	30°	0.2	3.54	6	2	50	34,100
BVREF-2040010	KY22485	40°	0.1	2.68	4	2	50	34,100
BVREF-2040020	KY22486	40°	0.2	2.61	4	2	50	34,100
BVREF-2060010	KY22487	60°	0.1	1.69	4	2	50	31,000
BVREF-2060020	KY22488	60°	0.2	1.65	4	2	50	31,000
BVREF-2090010	KY22489	90°	0.1	0.975	4	2	50	31,000
BVREF-2090020	KY22490	90°	0.2	0.95	4	2	50	31,000

## アタックスミス CBN面取りカッター

### BMC形

3枚刃  
直刃

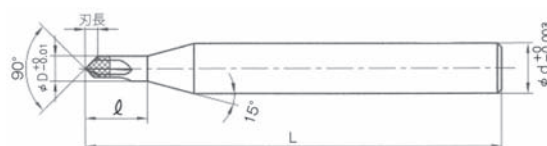

●切削条件 P.70

型番	ツールNo.	外径 D	有効長 ℓ	全長 L	柄径 d	先端 フラット径	価格
BMC-305015	KY22778	0.5	1.5	50	4	0.08	27,700
BMC-305050	KY22779	0.5	5	50	4	0.08	28,800
BMC-306015	KY22780	0.6	1.5	50	4	0.08	27,700
BMC-306050	KY22781	0.6	5	50	4	0.08	28,800
BMC-307020	KY22782	0.7	2	50	4	0.08	27,700
BMC-307060	KY22783	0.7	6	50	4	0.08	28,800
BMC-308020	KY22784	0.8	2	50	4	0.1	27,200
BMC-308060	KY22785	0.8	6	50	4	0.1	28,300
BMC-309030	KY22786	0.9	3	50	4	0.1	27,200
BMC-309080	KY22787	0.9	8	50	4	0.1	28,300
BMC-310030	KY22788	1	3	50	4	0.1	26,700
BMC-310080	KY22789	1	8	50	4	0.1	27,700
BMC-312040	KY22790	1.2	4	50	4	0.1	28,800
BMC-312100	KY22791	1.2	10	50	4	0.1	30,400
BMC-315040	KY22792	1.5	4	50	4	0.15	28,800
BMC-315100	KY22793	1.5	10	50	4	0.15	30,400
BMC-318050	KY22794	1.8	5	50	4	0.15	30,400
BMC-318150	KY22795	1.8	15	60	4	0.15	32,000
BMC-320050	KY22796	2	5	50	4	0.2	30,400
BMC-320150	KY22797	2	15	60	4	0.2	32,000
BMC-325060	KY22798	2.5	6	50	4	0.2	35,200
BMC-325200	KY22799	2.5	20	60	4	0.2	36,800
BMC-330060	KY22800	3	6	50	4	0.2	40,500
BMC-330200	KY22801	3	20	60	4	0.2	42,100
BMC-340200	KY22802	4	20	60	4	0.3	52,800
BMC-350300	KY22803	5	30	70	6	0.3	62,700
BMC-360300	KY22804	6	30	70	6	0.3	74,200



# アタックスミス CBN面取りカッター ダブル

## BUMW形

4枚刃  
直刃

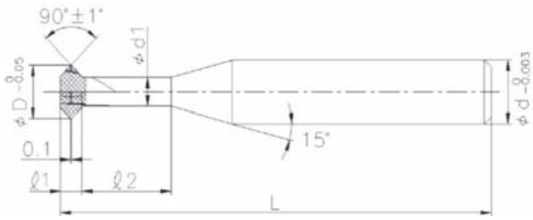

●切削条件 P.70

型番	ツールNo.	外径 D	刃厚 $\ell 1$	首下長 $\ell 2$	首径 d1	全長 L	柄径 d	価格
BUMW-401504	KY22805	1.5	0.4	4	1	50	4	34,400
BUMW-401508	KY22806	1.5	0.4	8	1	50	4	36,300
BUMW-402005	KY22807	2	0.8	5	1.1	50	4	36,300
BUMW-402010	KY22808	2	0.8	10	1.1	50	4	38,400
BUMW-402506	KY22809	2.5	1	6	1.4	50	4	42,100
BUMW-402512	KY22810	2.5	1	12	1.4	50	4	44,000
BUMW-403008	KY22811	3	1.2	8	1.7	50	4	48,600
BUMW-403016	KY22812	3	1.2	16	1.7	50	4	50,400
BUMW-403509	KY22813	3.5	1.4	9	2	50	4	60,300
BUMW-403518	KY22814	3.5	1.4	18	2	50	4	63,500
BUMW-404010	KY22815	4	1.6	10	2.3	50	4	60,300
BUMW-404020	KY22816	4	1.6	20	2.3	60	4	63,500
BUMW-404512	KY22817	4.5	2	12	2.4	50	6	71,000
BUMW-404524	KY22818	4.5	2	24	2.4	60	6	74,700
BUMW-405012	KY22819	5	2.2	12	2.7	50	6	71,000
BUMW-405024	KY22820	5	2.2	24	2.7	60	6	74,700
BUMW-405515	KY22821	5.5	2.4	15	3	60	6	84,500
BUMW-405530	KY22822	5.5	2.4	30	3	70	6	89,100
BUMW-406015	KY22823	6	3	15	2.9	60	6	84,500
BUMW-406030	KY22824	6	3	30	2.9	70	6	89,100

# アタックスミス CBN4枚刃リーマ

## BHR形

4枚刃  
スパイラル刃

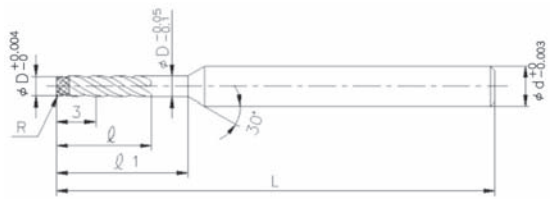

喰付寸法  
 $\phi 1.5 \sim \phi 2.03$  R0.2  
 $\phi 2.1 \sim \phi 3.99$  R0.3  
 $\phi 4.0 \sim \phi 4.99$  R0.4  
 $\phi 5.0 \sim \phi 6.03$  R0.5

●切削条件 P.70

型番	ツールNo.	刃径 D	溝長 $\ell$	有効長 $\ell 1$	全長 L	柄径 d	価格
BHR-4150	KY22707	1.5	8	10	50	3	24,000
BHR-4160	KY22708	1.6	8	10	50	3	24,000
BHR-4170	KY22709	1.7	8	10	50	3	24,000
BHR-4180	KY22710	1.8	8	10	50	3	24,000
BHR-4190	KY22711	1.9	8	10	50	3	24,000
BHR-4198	KY22712	1.98	13	15	50	3	26,000
BHR-4199	KY22713	1.99	13	15	50	3	26,000
BHR-4200	KY22714	2	13	15	50	3	26,000
BHR-4201	KY22715	2.01	13	15	50	3	26,000
BHR-4202	KY22716	2.02	13	15	50	3	26,000
BHR-4203	KY22717	2.03	13	15	50	3	26,000
BHR-4210	KY22718	2.1	13	15	50	3	26,000
BHR-4220	KY22719	2.2	13	15	50	3	26,000
BHR-4230	KY22720	2.3	13	15	50	3	26,000
BHR-4240	KY22721	2.4	13	15	50	3	26,000
BHR-4250	KY22722	2.5	13	15	50	3	26,700
BHR-4260	KY22723	2.6	13	15	50	3	26,700
BHR-4270	KY22724	2.7	13	15	50	3	26,700
BHR-4280	KY22725	2.8	13	15	50	3	26,700
BHR-4290	KY22726	2.9	13	15	50	3	26,700
BHR-4298	KY22727	2.98	18	20	60	3	33,400
BHR-4299	KY22728	2.99	18	20	60	3	33,400
BHR-4300	KY22729	3	18	20	60	3	33,400
BHR-4301	KY22730	3.01	18	20	60	3	33,400
BHR-4302	KY22731	3.02	18	20	60	3	33,400
BHR-4303	KY22732	3.03	18	20	60	3	33,400
BHR-4310	KY22733	3.1	18	20	60	4	33,400
BHR-4320	KY22734	3.2	18	20	60	4	33,400
BHR-4330	KY22735	3.3	18	20	60	4	33,400
BHR-4340	KY22736	3.4	18	20	60	4	33,400
BHR-4350	KY22737	3.5	18	20	60	4	35,200
BHR-4360	KY22738	3.6	18	20	60	4	35,200
BHR-4370	KY22739	3.7	18	20	60	4	35,200
BHR-4380	KY22740	3.8	18	20	60	4	35,200
BHR-4390	KY22741	3.9	18	20	60	4	35,200
BHR-4398	KY22742	3.98	23	25	60	4	40,000
BHR-4399	KY22743	3.99	23	25	60	4	40,000
BHR-4400	KY22744	4	23	25	60	4	40,000

型番	ツールNo.	刃径 D	溝長 ℓ	有効長 ℓ1	全長 L	柄径 d	価格
BHR-4401	KY22745	4.01	23	25	60	4	40,000
BHR-4402	KY22746	4.02	23	25	60	4	40,000
BHR-4403	KY22747	4.03	23	25	60	4	40,000
BHR-4410	KY22748	4.1	23	25	60	6	40,000
BHR-4420	KY22749	4.2	23	25	60	6	40,000
BHR-4430	KY22750	4.3	23	25	60	6	40,000
BHR-4440	KY22751	4.4	23	25	60	6	40,000
BHR-4450	KY22752	4.5	23	25	60	6	42,200
BHR-4460	KY22753	4.6	23	25	60	6	42,200
BHR-4470	KY22754	4.7	23	25	60	6	42,200
BHR-4480	KY22755	4.8	23	25	60	6	42,200
BHR-4490	KY22756	4.9	23	25	60	6	42,200
BHR-4498	KY22757	4.98	28	30	70	6	44,100
BHR-4499	KY22758	4.99	28	30	70	6	44,100
BHR-4500	KY22759	5	28	30	70	6	44,100
BHR-4501	KY22760	5.01	28	30	70	6	44,100
BHR-4502	KY22761	5.02	28	30	70	6	44,100
BHR-4503	KY22762	5.03	28	30	70	6	44,100
BHR-4510	KY22763	5.1	28	30	70	6	44,100
BHR-4520	KY22764	5.2	28	30	70	6	44,100
BHR-4530	KY22765	5.3	28	30	70	6	44,100
BHR-4540	KY22766	5.4	28	30	70	6	44,100
BHR-4550	KY22767	5.5	28	30	70	6	46,500
BHR-4560	KY22768	5.6	28	30	70	6	46,500
BHR-4570	KY22769	5.7	28	30	70	6	46,500
BHR-4580	KY22770	5.8	28	30	70	6	46,500
BHR-4590	KY22771	5.9	28	30	70	6	46,500
BHR-4598	KY22772	5.98	28	30	70	6	50,000
BHR-4599	KY22773	5.99	28	30	70	6	50,000
BHR-4600	KY22774	6	28	30	70	6	50,000
BHR-4601	KY22775	6.01	28	30	70	6	50,000
BHR-4602	KY22776	6.02	28	30	70	6	50,000
BHR-4603	KY22777	6.03	28	30	70	6	50,000